

# Monitoring Relays MRU, MRI, MRM

## 1 Features

- Voltage supply UC 12 – 48 V or UC 110 – 240 V
- Change-over contact
- Measuring inputs are separated galvanically from the supply
- Measuring range 0.1 ... 480 VAC / 0.1 ... 690 VDC / 0.1 ... 5 A
- Automatic range detection
- Min / Max and window function
- Individual function choice for each output
- Easy configuration
- Parameters adjustable over display
- LED state for each output
- Parameters are safe from supply-shutdown

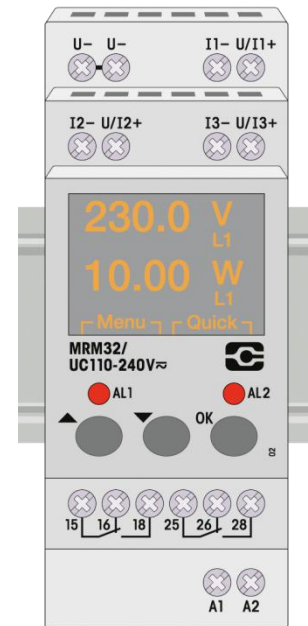

## 2 General descriptions

The monitoring relay family MR is developed for the supervision of AC and DC TRMS voltages.

The device is able to measure voltages and currents in 1 and 3-phase systems and determine the best measuring resolution with an automatic range selection. It possesses a permanent self-diagnosis. Therefore it is secured that an alarm will be released in any case of disturbance or failure.

The handling is very easy. Measuring values, user's parameters and the operation status are indicated on a display and can be adjust with the user-friendly service menu (3 keys).

Two outputs with changeover contacts for 6 A, 250 V are available. Both contacts can be switched independently of each other (2 relays). A red LED indicates the alarms.

The devices comply with the DIN standard 43880 and have a mounting width of 35 mm.

**Technical specification is subject to change without previous notice**

## 3 Order designation

Voltage Monitoring relay	1-phase	<b>MRU11/UC12-48V</b>
	3-phase	<b>MRU11/UC110-240V</b>
Current Monitoring relay	1-phase	<b>MRU32/UC12-48V</b>
	3-phase	<b>MRU32/UC110-240V</b>
Multifunction monitoring relay	1-phase	<b>MRI11/UC12-48V</b>
	3-phase	<b>MRI11/UC110-240V</b>
	1-phase	<b>MRI32/UC12-48V</b>
	3-phase	<b>MRI32/UC110-240V</b>
	1-phase	<b>MRM11/UC12-48V</b>
	3-phase	<b>MRM11/UC110-240V</b>
	1-phase	<b>MRM32/UC12-48V</b>
	3-phase	<b>MRM32/UC110-240V</b>

### 3.1 Type designation code

**MR M 3 2 / UC 12-48V**

**Product family**

**MR** = Monitoring relay

**Type**

**U** = Voltage monitoring  
**I** = Current monitoring  
**M** = Combined voltage and current monitoring

**System**

**1** = 1-phase monitoring  
**3** = 3-phase monitoring

**Power supply**

12 - 48 V  
110 - 240 V

**Current type**

**UC** = Universal current AC/DC

**Output configuration**

**1** = One output relay c.o.  
**2** = Two output relays c.o.

### 4 Connection diagram

MRU11  
(-)N L(+)

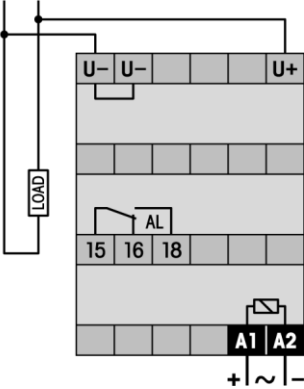

MRI11  
(-)N L(+)

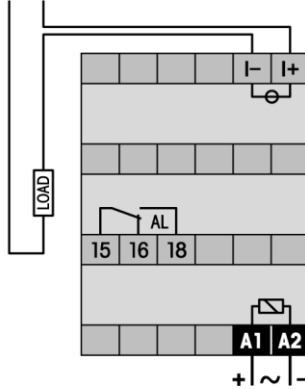

MRM11  
(-)N L(+)

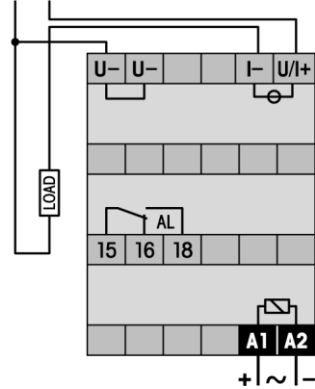

MRU32  
N L1 L2 L3

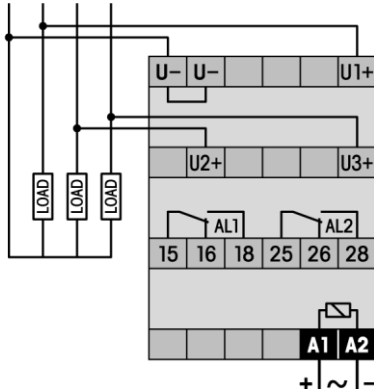

MRI32  
N L1 L2 L3

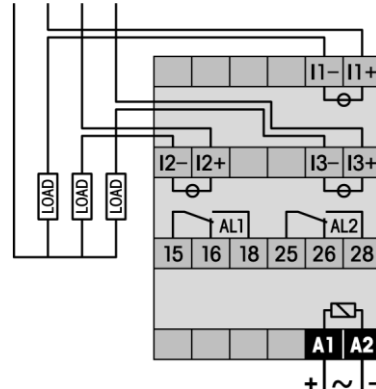

MRM32  
N L1 L2 L3

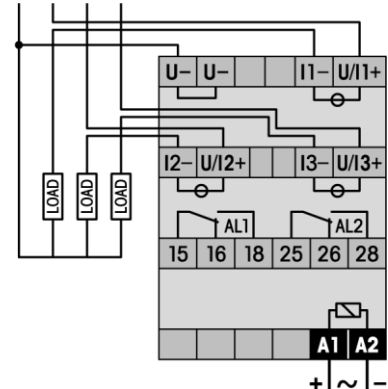

## 5 Specifications

### 5.1 General data

#### 5.1.1 Mechanical data

Outside dimensions:	Housing system DIN, B x H x T: 36 x 90 x 57 mm	
Connector:	Screw terminal 2.5 mm <sup>2</sup>	
Max. screw tightening torque:	0.4 Nm	
Protection:	IP20 (Electronic: IP40)	
Case material:	Lexan EXL 9330	
Weight:	MRx11: 107 g	MRx32: 125 g
Fastening:	TS35 DIN/EN 60715	

#### 5.1.2 Ambient condition

Storage temperature:	-40 °C ... +85 °C
Operating temperature:	-40 °C ... +60 °C (Railway: -40 °C ... +70 °C; Display -20 ... +60 °C)
Relative humidity:	10 % ... +95 % (not condensing)

#### 5.1.3 Life cycle

Life cycle:	> 100 000 h (at 25 °C)
Relays contacts:	see chapter 'Outputs'

### 5.2 Electrical data

#### 5.2.1 Supply

Version:	.../UC110-240V	.../UC12-48V
Nominal operating voltage (AC/DC):	110...240 V	12...48 V
Operating voltage (AC/DC):	85...250 V	10...60 V
Frequency range:	16...63 Hz	16...63 Hz
Current consumption:	18 mA	180 mA
Power consumption:	2.6 VA / 1.5 W	3.2 VA / 1.6 W

#### 5.2.2 Voltage inputs

Nominal input range:	± 0.1 ... 690 V DC or 0.1 ... 480 V AC
Input voltage max:	690 V DC / 480 V AC
Frequency range (Fast / Slow mode)	46...150 Hz / 15...150 Hz
Measuring error:	see chapter 6
Display resolution:	0.1 V
Input impedance:	1 MΩ

#### 5.2.3 Current inputs

Nominal input range:	0.1 ... 5 A
Input current max:	7 A
Frequency range (Fast / Slow mode)	46...150 Hz / 15...150 Hz
Measuring error:	see chapter 6
Display resolution:	0.1 A
Input impedance:	5 mΩ

### 5.3 Time response

Time response:	Fast mode	Slow mode
MRU11 / MRI11	Min. 105 ms	Min. 150 ms
MRU32 / MRI32	Min. 155 ms	Min. 290 ms
MRM11	Min. 130 ms	Min. 220 ms
MRM32	Min. 230 ms	Min. 500 ms

#### 5.3.1 Alarm delay

Adjust range (ton / toff):	0.5 ... 999.9 s
Adjust and display resolution:	0.1 s
Startup delay min:	2.5 s (adjustable)
Parameter storage time typ:	1 s

### 5.4 Outputs

Contact: 1 or 2 c.o.  
 Contact material: AgNi 0.15  
 Switching voltage: 250 V AC  
 Switching power AC-1: 1250 VA  
 Switching current: 6 A

Recommended minimum load: 10 mA / 10 V  
 Mechanical life time: 30 x 10<sup>6</sup>

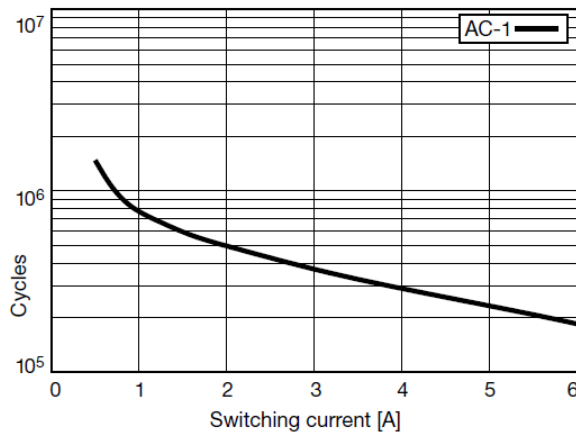
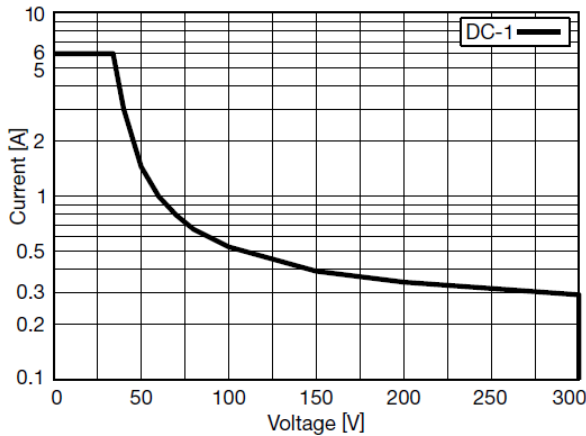

### 5.5 Voltage stability

Open contact: 1.0 kV (RMS, 1 min)  
 Between adjoined contacts: 2.5 kV (RMS, 1 min)  
 Measuring input – Contact: 4.0 kV (RMS, 1 min)  
 Measuring input – Supply: 4.0 kV (RMS, 1 min)  
 Measuring input – Measuring input: 2.5 kV (RMS, 1 min)

## 6 Measurement parameters – ranges – accuracy

Measuring	Unit	MRU11	MRI11	MRM11	MRU32	MRI32	MRM32	Measuring range AC per phase		Measuring range DC per phase		Adjustable range		Adjustment	Max. measuring error AC		Max. measuring error DC	
								Min	Max	Min	Max	Min	Max		Resolution	+/- % Mv.	+/- Unit.	+/- % Mv.
U	Voltage	V	X	X	X	X	X	0.0	480.0	-690.0	690.0	-700.0	700.0	0.1	1.0	0.2	0.5	0.1
I	Current	A	X	X	X	X	X	0.0	5.0	-5.0	5.0	-6.0	6.0	0.1	5.0	0.1	2.5	0.1
f	Frequency	Hz	X	X	X	X	X	16	100			15	150	1	5.0	0.1		
Δφ	Phase angle	°			X		X	0	359			0	359	1	f * 0.2	1.0		
P	Active power	W		X			X	0	2400	-3450	3450	-4200	4200	1	5.0	0.2	2.5	0.2
S	Apparent power	VA		X			X	0	500			-4200	4200	1	5.0	0.2	2.5	0.2
cosφ	Power factor			X			X	0.00	1.00			0.00	1.00	0.05	5.0	0.1		
Measuring inputs			1	1	1	3	3	3										
Relay outputs			1	1	1	2	2	2										

- The measurement error applies over the entire temperature range.
- The measurement error applies to the slow mode.

## 7 Functions

This device contains three monitoring functions.

### Window function

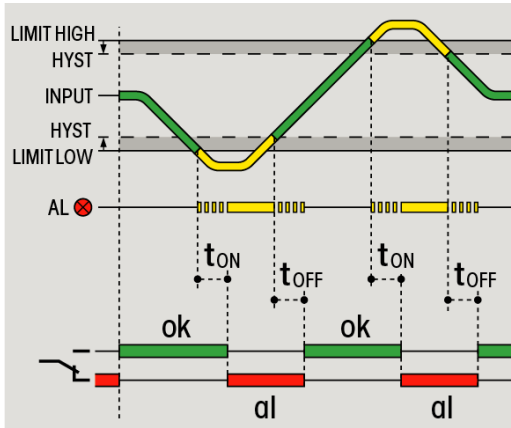

### Minimal value

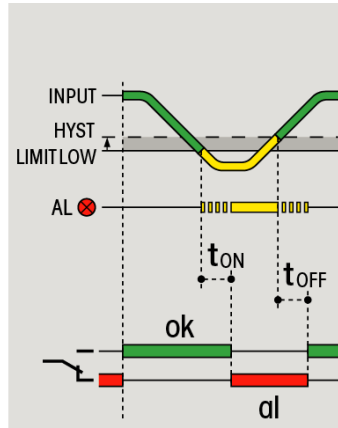

### Maximal value

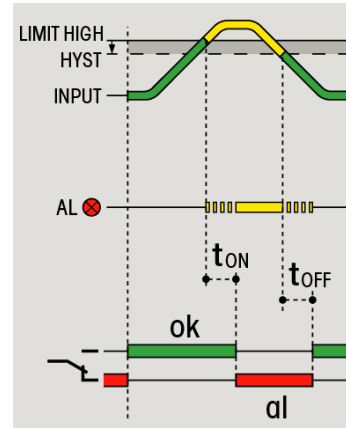

gn ye rd  
■ ok ■ fail ■ alarm Alarm delay:  $t_{OFF}$ ,  $t_{ON}$

### 7.1 Switching state display

LED		Alarm state	Relays
Not glowing	————	OK (no Alarm)	On
Glowing constantly	.....	Alarm	Off
Flashing short	▬▬▬▬	Alarm $t_{ON}$ run	On
Flashing long	▬▬▬▬	no Alarm $t_{OFF}$ run	Off



Same behavior for the second output.

## 8 Application notes

### 8.1 Installation instructions

- The devices comply with the DIN standard 43880 and have a mounting width of 35 mm.
- The current measurement of monitoring relays MRI and MRM is realized with Hall elements. Therefore, other devices that produce magnetic fields (e.g., contactors) should be mounted with at least a distance of 50 mm to the monitoring relay. Otherwise, the magnetic field could influence the measurement of the current.

### 8.2 Operating instructions

- ▲  Increase the numeric value or select the next parameter. Toggle function on simulation mode.
  - ▼  Decrease the numeric value or select the previous parameter. Toggle function on simulation mode.
  - OK  Takes over the selected value and jumps to the next menu point. By pushing and holding this button, it jumps back to the previous menu point or the main display without saving.
- Menu timeout is 20 s. If no button is pushed within this period, the device will jump back to the home screen.
  - Every 5 seconds, the display is doing a reset. Therefore, a flickering on the screen will occur.
  - The display of the MRx32 will change the displayed values every 2 seconds.
  - The default parameters are set as follows:  
**Hysteresis: 5 %, Alarm delay: No delay, Monitoring function: Off**
  - In the quick menu: If the monitoring function was set to OFF, the function will automatically change to OVER.
  - When leaving the menu, the parameters are stored. During this time (typ. 1 s), no monitoring is executed and the relay state remains unchanged. The LED flashes during the parameter storage process.
  - The device disposes of a permanent self-diagnosis. Therefore it is secured that an alarm will be released in any case of disturbance or failure. An error will be indicated with a specific numeric code on the display.
  - In MRU and MRM devices, the frequency is detected on L1 when the voltage is higher than 1 V (TRMS). In MRI devices when current on L1 exceeds 0.1 A (TRMS).
  - The power P (only MRM devices) is calculated if  $U > 1 \text{ V}$  and  $I > 0.1 \text{ A}$ , otherwise  $S = P$  and  $PF = 1$ .
  - If no zero-crossing at voltage or current exist, a minus sign is indicated if the values are negative (TRMS is positive by definition). Every phase is checked separately.
  - The calculation of the effective power is, based on the low sample rate, not precise when the measured voltage or current are not sine-shaped. The accuracy of the power factor also depends on it.
  - The power factor is determined with apparent and effective power. If the frequency is zero, the effective power will be equalized to the apparent power. Therefore  $PF = 1$ .
  - Values greater than 1000 are indicated with one, k' (kilo sign). Therefore the biggest displayable number is 9999 k (Thousand). The smallest displayed value therefore is 0.001.
  - The sum of the phase angle is  $360^\circ$ . L1 and L2 are measured; L3 is then calculated ( $360^\circ - L1 - L2$ ).
  - When switching the relays, the measuring cycle time and the switch time of the relays are compensated.

### 8.3 Menu navigation

**MR...: Menüführung**  
 ▶ Wert erhöhen / Nächster Menüpunkt  
 ▶ Wert senken / Vorheriger Menüpunkt  
 OK Wert bestätigen und speichern / Menüpunkt anwählen  
 OK (long hold) Abbruch ohne Speichern / Zurück zum vorigen Menüpunkt  
 Wenn während da's keine Taste betätigt wird, fällt das Gerät in den Normalzustand, ohne den letzten Parameter zu speichern.  
 Werksinstellung beinhaltet voreingestellte Parameter:  
 Hysteresis: 5%; Delay: No delay; Monitoring: Off

**MR...: Guidage par menu**  
 ▶ Incrémenter valeur / Prochain point menu  
 ▶ Décrémenter valeur / Point menu précédent  
 OK Confirmer et sauvegarder valeur / Sélectionner point menu  
 OK (long hold) Annuler sans enregistrer / Retour vers menu précédent  
 Si aucun bouton n'est active pendant 20 s., l'appareil revient à l'état normal sans enregistrer la dernière paramètre.  
 Configuration par défaut:  
 Hysteresis: 5%; Delay: No delay; Monitoring: Off

**MR...: Menu navigation**  
 ▶ Increase value / Go to next menu point  
 ▶ Decrease value / Go to previous menu point  
 OK Confirm and save value / Select menu point  
 OK (long hold) Cancel without saving / Back to previous menu  
 If no key is activated during 20 s., the device returns to the default state without saving the last parameter.  
 Factory setting includes default parameters:  
 Hysteresis: 5%; Delay: No delay; Monitoring: Off

**Anzeigen-Beispiele / Examples of afficheage / Example screens**

Wenn die Überwachungsfunktion OFF eingestellt was, wird hier automatisch zur Funktion OVER gewechselt.  
 Si le mode de surveillance OFF était choisi, il sera change automatiquement vers OVER.  
 If monitoring mode OFF was selected, change to function OVER is made automatically.

**Quick**

**Menu**

**Alarm**

**Relay**

**Relay function**

### 9 Dimensions

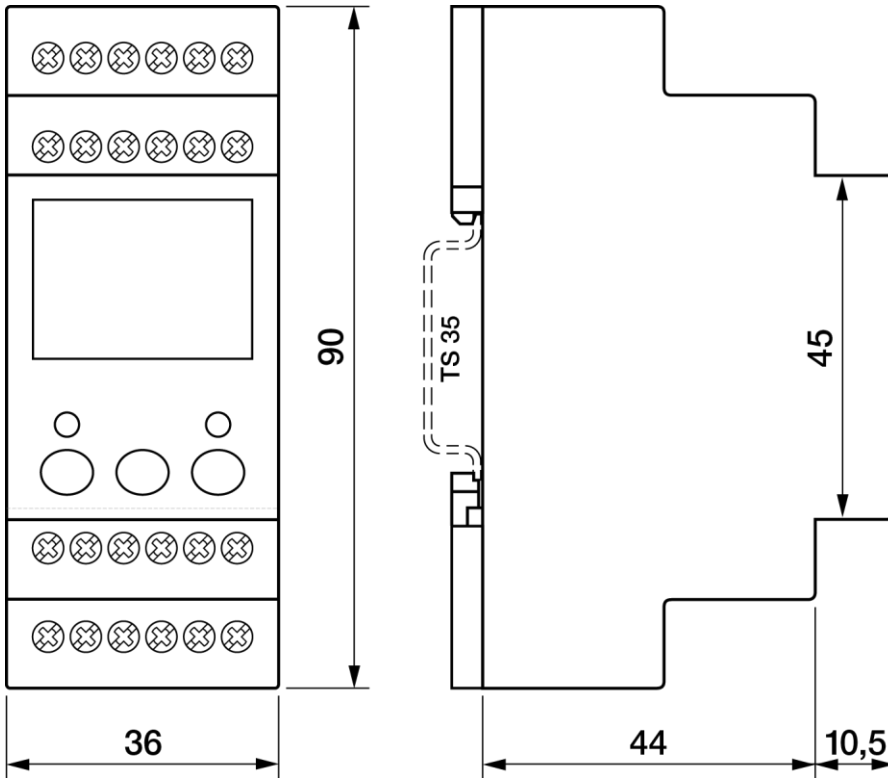

### 10 Standards

Low voltage guidelines	EN 60730-1:2000 EN 60947-1:2007
Installation devices	DIN 43880
Interference immunity	EN 61000-6-2:2005 EN 50121-3-2:2006
Interference emission	EN 61000-6-3:2007 EN 50121-3-2:2006
Approbation, Identification	CE UL (approval in process)

### 11 Revision history

Version	Revision date	Responsible	Modifications
55005-38-57-401	23.03.2012	Hy/Li	Version 1