

PERFORMANCE
MADE
SMARTER

Product manual

6331

2-wire programmable transmitter

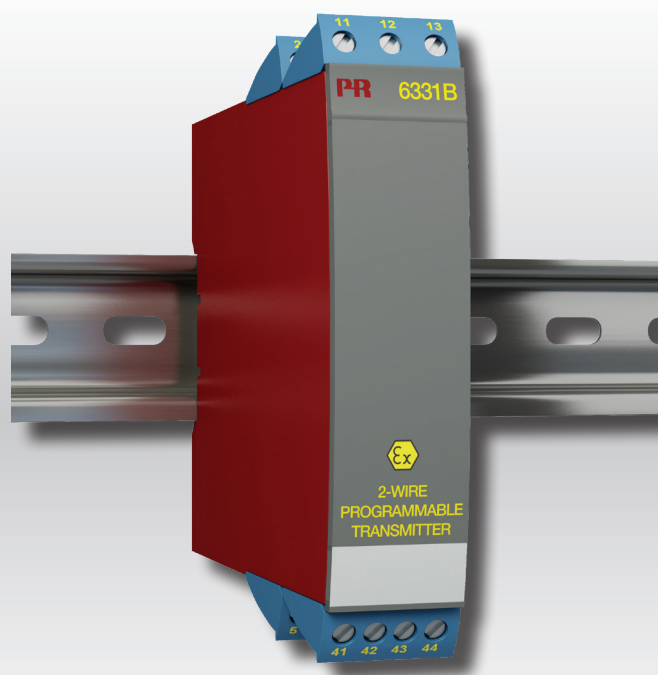

TEMPERATURE | I.S. INTERFACES | COMMUNICATION INTERFACES | MULTIFUNCTIONAL | ISOLATION | DISPLAY

No. 6331V107-UK
From serial no.: 159740001

PR
electronics

6 Product Pillars

to meet your every need

Individually outstanding, unrivalled in combination

With our innovative, patented technologies, we make signal conditioning smarter and simpler. Our portfolio is composed of six product areas, where we offer a wide range of analog and digital devices covering over a thousand applications in industrial and factory automation. All our products comply with or surpass the highest industry standards, ensuring reliability in even the harshest of environments and have a 5-year warranty for greater peace of mind.



Temperature

Our range of temperature transmitters and sensors provides the highest level of signal integrity from the measurement point to your control system. You can convert industrial process temperature signals to analog, bus or digital communications using a highly reliable point-to-point solution with a fast response time, automatic self-calibration, sensor error detection, low drift, and top EMC performance in any environment.



I.S. Interface

We deliver the safest signals by validating our products against the toughest safety standards. Through our commitment to innovation, we have made pioneering achievements in developing I.S. interfaces with SIL 2 Full Assessment that are both efficient and cost-effective. Our comprehensive range of analog and digital intrinsically safe isolation barriers offers multifunctional inputs and outputs, making PR an easy-to-implement site standard. Our backplanes further simplify large installations and provide seamless integration to standard DCS systems.



Communication

We provide inexpensive, easy-to-use, future-ready communication interfaces that can access your PR installed base of products. All the interfaces are detachable, have a built-in display for readout of process values and diagnostics, and can be configured via push-buttons. Product specific functionality includes communication via Modbus and Bluetooth and remote access using our PR Process Supervisor (PPS) application, available for iOS and Android.



Multifunction

Our unique range of single devices covering multiple applications is easily deployable as your site standard. Having one variant that applies to a broad range of applications can reduce your installation time and training, and greatly simplify spare parts management at your facilities. Our devices are designed for long-term signal accuracy, low power consumption, immunity to electrical noise and simple programming.



Isolation

Our compact, fast, high-quality 6 mm isolators are based on microprocessor technology to provide exceptional performance and EMC-immunity for dedicated applications at a very low total cost of ownership. They can be stacked both vertically and horizontally with no air gap separation between units required.



Display

Our display range is characterized by its flexibility and stability. The devices meet nearly every demand for display readout of process signals, and have universal input and power supply capabilities. They provide a real-time measurement of your process value no matter the industry, and are engineered to provide a user-friendly and reliable relay of information, even in demanding environments.

2-wire programmable transmitter 6331

Table of contents

Technical characteristics	4
Mounting / installation	4
Applications	4
Order	5
Electrical specifications	5
Connections	8
Block diagram	9
Programming	9
ATEX Installation Drawing - 6331A	10
ATEX Installation Drawing - 6331B	12
IECEX Installation Drawing - 6331A	14
IECEX Installation Drawing - 6331B	16
CSA Installation Drawing - 6331A	18
CSA Installation Drawing - 6331B	20
FM Installation Drawing - 6331B	22
Document history	24

2-wire programmable transmitter 6331

- RTD, TC, Ohm, or mV input
- Extremely high measurement accuracy
- Galvanic isolation
- Programmable sensor error value
- 1- or 2-channel version

Application

- Linearised temperature measurement with Pt100... Pt1000, Ni100...Ni1000, or TC sensor.
- Conversion of linear resistance variation to a standard analogue current signal, for instance from valves or Ohmic level sensors.
- Amplification of a bipolar mV signal to a standard 4...20 mA current signal.

Technical characteristics

- Within a few seconds the user can program PR6331 to measure temperatures within all ranges defined by the norms.
- The RTD and resistance inputs have cable compensation for 2-, 3- and 4-wire connection.
- Continuous check of vital stored data for safety reasons.

Mounting / installation

- Mounted vertically or horizontally on a DIN rail. Using the 2-channel version up to 84 channels per metre can be mounted.
- The 6331A can be mounted in zone 2 and zone 22 / Class I, Division 2, Groups A, B, C, D.
- The 6331B can be mounted in zone 0, 1, 2 and zone 20, 21, 22 including M1 / Class I, Division 1, Groups A, B, C, D.

Applications

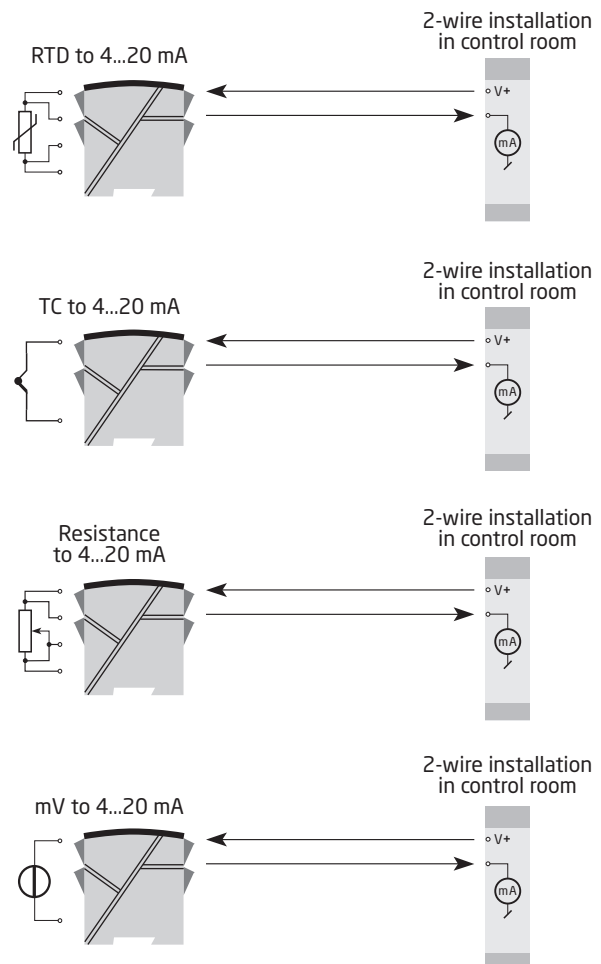

Order

Type	Version	Galvanic isolation	Channels
6331	General purpose : A	1500 VAC : 2	Single : A
	Hazardous area : B		Double : B

*NB! Please remember to order CJC connectors type 5910 / 5910Ex (channel 1) and 5913 / 5913Ex (channel 2) for TC inputs with an internal CJC.

Electrical specifications

Environmental conditions:

Specification range	-40°C to +85°C
Storage temperature	-40°C to +85°C
Calibration temperature.	20...28°C
Humidity.	< 95% RH (non-cond.)
Protection degree	IP20

Mechanical specifications:

Dimensions (H x W x D)	109 x 23.5 x 104 mm
Weight (1 / 2 channels)	145 / 185 g
DIN rail type.	DIN EN/IEC 60715 - 35 mm
Wire size.	0.13...2.08 mm ² / AWG 26...14 stranded wire
Screw terminal torque.	0.5 Nm

Common specifications:

Supply voltage, DC	
6331A.	7.2...35 VDC
6331B.	7.2...30 VDC
Max. required power, 1 / 2 channels, 6331A	0.8 W / 1.6 W
Max. required power, 1 / 2 channels, 6331B	0.7 W / 1.4 W
Internal power dissipation, 6331A	0.17...0.8 W
Internal power dissipation, 6331B	0.17...0.7 W
Voltage drop	7.2 VDC
Isolation voltage, test / operation.	1.5 kVAC / 50 VAC
Warm-up time.	5 min.
Programming	Loop Link
Signal / noise ratio.	Min. 60 dB
Response time (programmable)	1...60 s
EEPROM error check	< 3.5 s
Signal dynamics, input	20 bit
Signal dynamics, output	16 bit
Effect of supply voltage variation.	< 0.005% of span / VDC

Accuracy, the greater of general and basic values:

General values		
Input type	Absolute accuracy	Temperature coefficient
All	$\leq \pm 0.05\%$ of span	$\leq \pm 0.01\%$ of span / °C

Basic values		
Input type	Basic accuracy	Temperature coefficient
RTD	$\leq \pm 0.2^\circ\text{C}$	$\leq \pm 0.01^\circ\text{C}/^\circ\text{C}$
Lin. R	$\leq \pm 0.1 \Omega$	$\leq \pm 10 \text{ m}\Omega / ^\circ\text{C}$
Volt	$\leq \pm 10 \mu\text{V}$	$\leq \pm 1 \mu\text{V} / ^\circ\text{C}$
TC type: E, J, K, L, N, T, U	$\leq \pm 1^\circ\text{C}$	$\leq \pm 0.05^\circ\text{C} / ^\circ\text{C}$
TC type: B, R, S, W3, W5, LR	$\leq \pm 2^\circ\text{C}$	$\leq \pm 0.2^\circ\text{C} / ^\circ\text{C}$

EMC - immunity influence.	$< \pm 0.5\%$ of span
Extended EMC immunity: NAMUR NE 21, A criterion, burst	$< \pm 1\%$ of span

Electrical specifications, input:

Max. offset 50% of selec. max. value

RTD and linear resistance input:

RTD type	Min. value	Max. value	Min. span	Standard
Pt100	-200°C	+850°C	25°C	IEC 60751
Ni100	-60°C	+250°C	25°C	DIN 43760
Lin. R	0 Ω	5000 Ω	30 Ω	-----

Cable resistance per wire (max.). 5 Ω

Sensor current Nom. 0.2 mA

Effect of sensor cable resistance (3- / 4-wire) $< 0.002 \Omega/\Omega$

Sensor error detection Yes

TC input:

Type	Min. temperature	Max. temperature	Min. span	Standard
B	+400°C	+1820°C	100°C	IEC584
E	-100°C	+1000°C	50°C	IEC584
J	-100°C	+1200°C	50°C	IEC584
K	-180°C	+1372°C	50°C	IEC584
L	-100°C	+900°C	50°C	DIN 43710
N	-180°C	+1300°C	50°C	IEC584
R	-50°C	+1760°C	100°C	IEC584
S	-50°C	+1760°C	100°C	IEC584
T	-200°C	+400°C	50°C	IEC584
U	-200°C	+600°C	50°C	DIN 43710
W3	0°C	+2300°C	100°C	ASTM E988-90
W5	0°C	+2300°C	100°C	ASTM E988-90
LR	-200°C	+800°C	50°C	GOST 3044-84

Cold junction compensation $< \pm 1.0^\circ\text{C}$

Sensor error detection Yes

Sensor error current:

When detecting	Nom. 33 μ A
Else.	0 μ A

Voltage input:

Measurement range	-12...800 mV
Min. span	5 mV
Input resistance	10 M Ω

Output:

Current output:

Signal range.	4...20 mA
Min. signal range.	16 mA
Updating time	440 ms
Output signal at EEprom error	\leq 3.5 mA
Load resistance.	\leq (V _{supply} - 7.2) / 0.023 [Ω]
Load stability	$<$ \pm 0.01% of span / 100 Ω

Sensor error detection:

Programmable	3.5...23 mA
NAMUR NE43 Upscale	23 mA
NAMUR NE43 Downscale.	3.5 mA

Of span = Of the presently selected range

Observed authority requirements:

EMC.	2014/30/EU
ATEX	2014/34/EU
RoHS	2011/65/EU
EAC	TR-CU 020/2011
EAC Ex	TR-CU 012/2011

I.S. / Ex approvals:

ATEX	KEMA 06ATEX0015 X
IECEX.	IECEX DEK 14.0047X
FM	FM17US0013X
CSA	1125003
EAC Ex	RU C-DK.HA65.B.00355/19

Connections

Inputs:

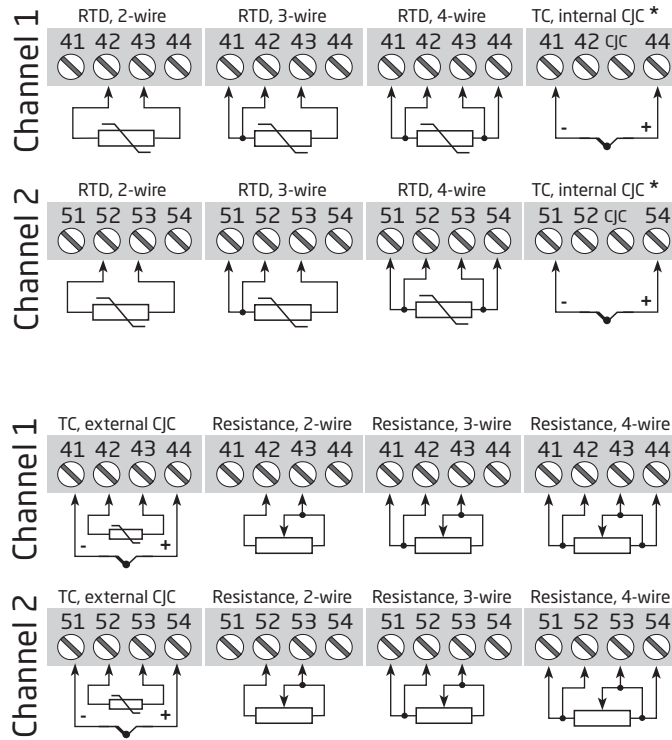

Inputs:

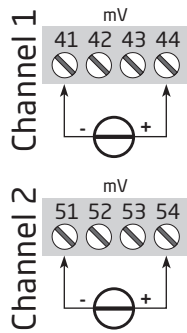

Outputs:

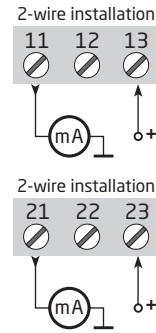

Block diagram

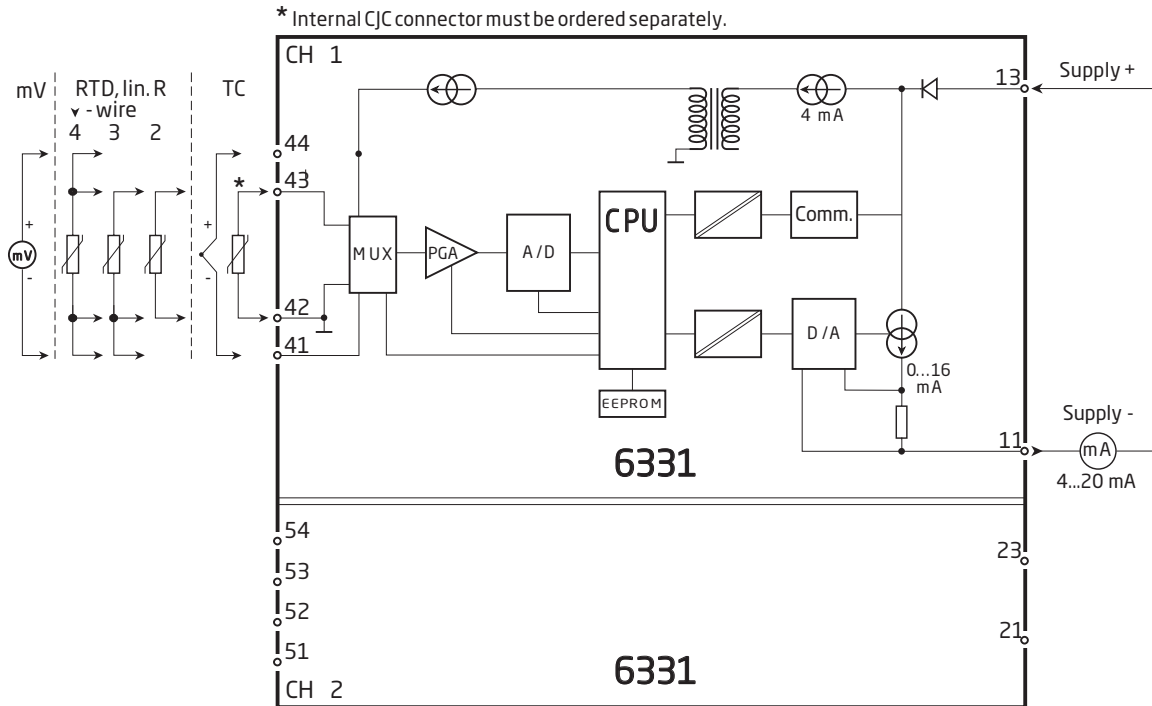

Programming

- Loop Link is a communications interface that is needed for programming 6331.
- For programming please refer to the drawing below and the help functions in PRset.
- When communicating with non-installed modules, connectors 11, 12, 13 (channel 1) and 21, 22, 23 (channel 2) can be dismantled in the safe area to connect the terminals of the communications interface to the pins.
- Loop Link is not approved for communication with modules installed in hazardous (Ex) areas.

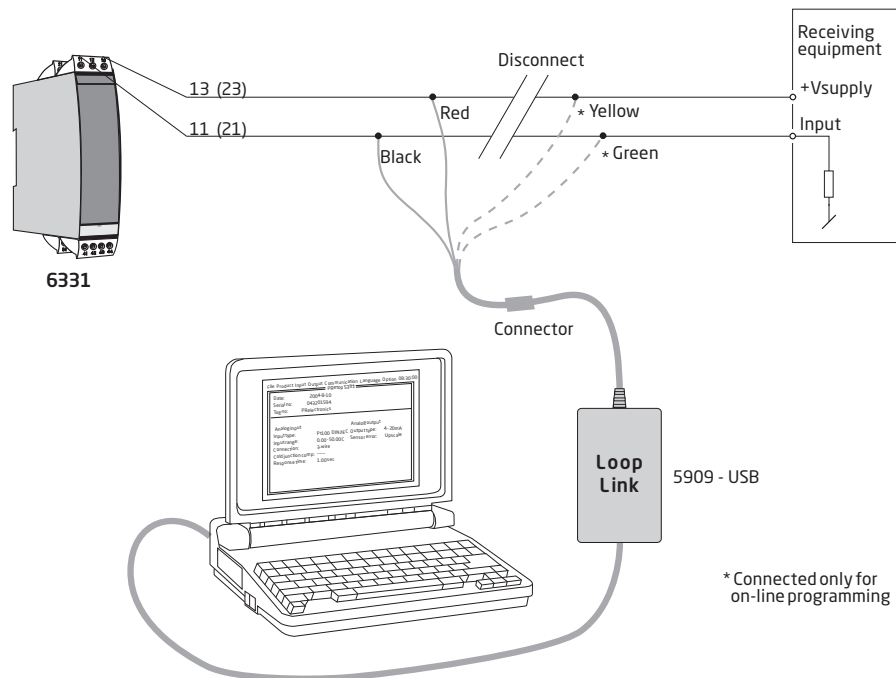

ATEX Installation drawing



For safe installation of 6331A or the 6334A the following must be observed. The module shall only be installed by qualified personnel who are familiar with the national and international laws, directives and standards that apply to this area.

Year of manufacture can be taken from the first two digits in the serial number.

ATEX Certificate KEMA 06 ATEX0115X

Marking



II 3 G Ex nA [ic] IIC T6..T4 Gc
II 3 G Ex ic IIC T6..T4 Gc
II 3 D Ex ic IIIC Dc

Standards

EN 60079-0:2012, EN 60079-11:2012, EN 60079-15:2010

T4: -40°C to 85 °C
T6: -40°C to 60 °C

Terminal:
41,42,43,44 /
51,52,53,54

Ex nA [ic]

U_o: 9.6 VDC
I_o: 25 mA
P_o: 60 mW
L_o: 33 mH
C_o: 2.4 µF

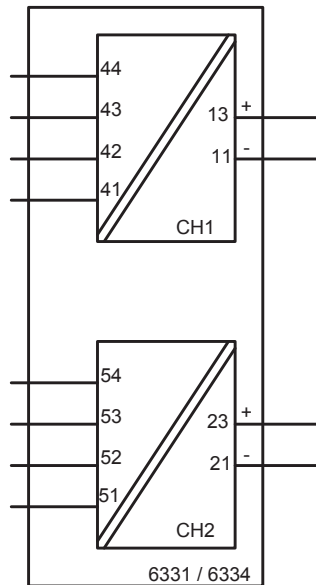

Hazardous Area Zone 2

Terminal:
11-13 / 21-23

Ex nA
U_{max} ≤ 35 VDC

Ex ic
U_i = 35 VDC
L_i = 10 µH
C_i = 1.0 nF

General installation instructions

To avoid risk of ignition during installation and maintenance appropriate safety measures against electrostatic discharge (ESD) are to be considered.

The sensor circuit is not infallibly galvanic isolated from the supply output circuit. However, the galvanic isolation between the circuits is capable of withstanding a test voltage of 500Vac during 1 minute.

For installation in a potentially explosive gas atmosphere, the following instructions apply:

If the transmitter is applied in type of protection "Ex nA", it shall be installed in an enclosure that is Ex nA certified according to IEC-EN 60079-15 or "Ex e" certified and suitable for the application and correctly installed.

Cable entry devices and blanking elements shall fulfill the same requirements.

For installation in a potentially explosive dust atmosphere, the following instructions apply:

If the transmitter is supplied with an intrinsically safe signal "ic" and interfaces an intrinsically safe signal "ic" (e.g. a passive device), the transmitter shall be mounted in a metal enclosure that provides a degree of protection of at least IP6X according to EN/IEC 60529, and that is suitable for the application. Cable entry devices and blanking elements shall fulfill the same requirements. The surface temperature of the enclosure is equal to the ambient temperature +20K for a dust layer with a maximum thickness of 5 mm.

ATEX Installation drawing



For safe installation of 6331Bxx or 6334Bxx the following must be observed. The module shall only be installed by qualified personnel who are familiar with the national and international laws, directives and standards that apply to this area.
Year of manufacture can be taken from the first two digits in the serial number.

ATEX Certificate KEMA 06ATEX 0115X

Marking  II 1 G Ex ia IIC T6..T4 Ga
II 1 D Ex ia IIIC Da
I M 1 Ex ia I Ma

Standards EN 60079-0 : 2012, EN 60079-11 : 2012, EN 60079-26 : 2007

Hazardous area
Zone 0, 1, 2, 20, 21, 22

T4: $-40 \leq T_a \leq 85^\circ\text{C}$
T5: $-40 \leq T_a \leq 60^\circ\text{C}$
T6: $-40 \leq T_a \leq 40^\circ\text{C}$

**Terminal:
41,42,43,44**
Uo: 9.6 VDC
Io: 25 mA
Po: 60 mW
Lo: 33 mH
Co: 2.4 μF

**Terminal:
51,52,53,54**
Uo: 9.6 VDC
Io: 25 mA
Po: 60 mW
Lo: 33 mH
Co: 2.4 μF

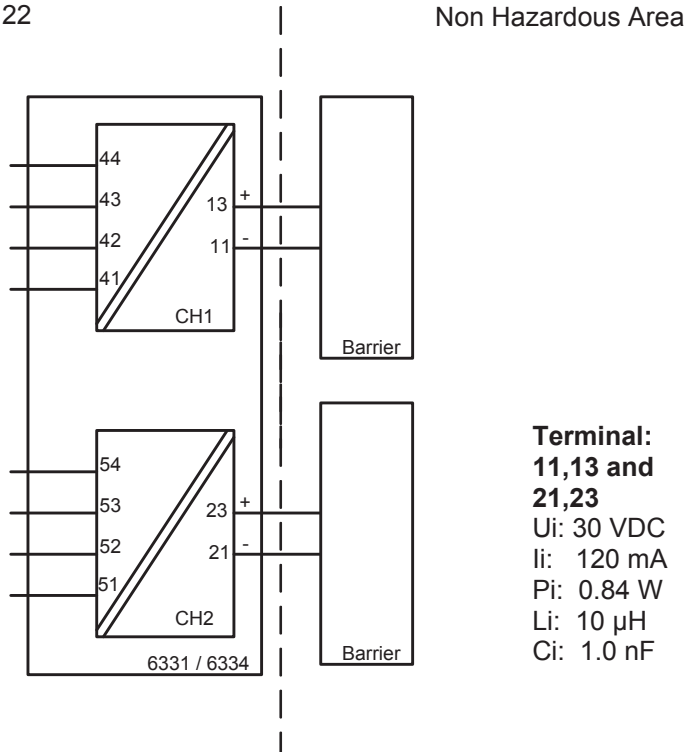

**Terminal:
11,13 and
21,23**
Ui: 30 VDC
Ii: 120 mA
Pi: 0.84 W
Li: 10 μH
Ci: 1.0 nF

General installation instructions

To avoid risk of ignition during installation and maintenance appropriate safety measures against electrostatic discharge (ESD) are to be considered.

The sensor circuit is not infallibly galvanic isolated from the supply output circuit. However, the galvanic isolation between the circuits is capable of withstanding a test voltage of 500Vac during 1 minute.

For installation in a potentially explosive gas atmosphere the following instructions apply:

To avoid risk of ignition due to electrostatic discharge (ESD) the transmitter shall be mounted in an enclosure providing a degree of protection of at least IP20 according to EN/IEC 60529.

Ambient temperature range:

T4: $-40 \leq T_a \leq 85^{\circ}\text{C}$

T5: $-40 \leq T_a \leq 60^{\circ}\text{C}$

T6: $-40 \leq T_a \leq 40^{\circ}\text{C}$

For installation in a potentially explosive dust atmosphere, the following instructions apply:

The transmitter shall be mounted in a metal enclosure or equivalent that is providing a degree of protection of at least IP6X according to EN/IEC 60529 that is suitable for the application and correctly installed. Cable entries and blanking elements shall be used that are suitable for the application and correctly installed. The surface temperature of the enclosure is equal to the ambient temperature +20K for a dust layer with a maximum thickness of 5 mm.

Ambient temperature range:

T4: $-40 \leq T_a \leq 85^{\circ}\text{C}$

For installation in a potentially explosive atmosphere in mines, the following instructions apply:

The transmitter shall be mounted in an enclosure providing a degree of protection of at least IP6X according to EN/IEC 60529. Cable entries and blanking elements shall be used that are suitable for the application and correctly installed.

Ambient temperature range:

T4: $-40 \leq T_a \leq 85^{\circ}\text{C}$

IECEx Installation drawing

For safe installation of 6331A or the 6334A the following must be observed. The module shall only be installed by qualified personnel who are familiar with the national and international laws, directives and standards that apply to this area.
Year of manufacture can be taken from the first two digits in the serial number.

IECEx Certificate IECEx DEK 14.0047X

Marking
 Ex nA [ic] IIC T6..T4 Gc
 Ex ic IIC T6..T4 Gc
 Ex ic IIIC Dc

Standards IEC 60079-0 : 2011, IEC 60079-11 : 2011, IEC 60079-15 : 2010

T4: -40°C to 85 °C
 T6: -40°C to 60 °C

Terminal:
41,42,43,44 /
51,52,53,54

Ex nA [ic]

U_o: 9.6 VDC
 I_o: 25 mA
 P_o: 60 mW
 L_o: 33 mH
 C_o: 2.4 µF

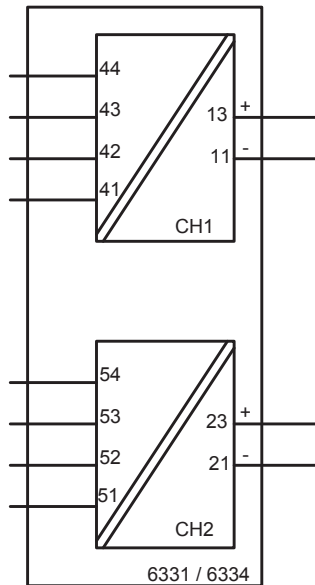

Hazardous Area Zone 2

Terminal:
11-13 / 21-23

Ex nA
 U_{max} ≤ 35 VDC

Ex ic
 U_i = 35 VDC
 L_i = 10 µH
 C_i = 1.0 nF

General installation instructions

To avoid risk of ignition during installation and maintenance appropriate safety measures against electrostatic discharge (ESD) are to be considered.

The sensor circuit is not infallibly galvanic isolated from the supply output circuit. However, the galvanic isolation between the circuits is capable of withstanding a test voltage of 500Vac during 1 minute.

For installation in a potentially explosive gas atmosphere, the following instructions apply:

If the transmitter is applied in type of protection "Ex nA", it shall be installed in an enclosure that is Ex nA certified according to IEC-EN 60079-15, or "Ex e" certified and suitable for the application and correctly installed.

Cable entry devices and blanking elements shall fulfill the same requirements

For installation in a potentially explosive dust atmosphere, the following instructions apply:

If the transmitter is supplied with an intrinsically safe signal "ic" and interfaces an intrinsically safe signal "ic" (e.g. a passive device), the transmitter shall be mounted in a metal enclosure that provides a degree of protection of at least IP6X according to EN/IEC 60529, and that is suitable for the application. Cable entry devices and blanking elements shall fulfill the same requirements. The surface temperature of the enclosure is equal to the ambient temperature +20K for a dust layer with a maximum thickness of 5 mm.

IECEx Installation drawing

For safe installation of 6331Bxx or 6334Bxx the following must be observed. The module shall only be installed by qualified personnel who are familiar with the national and international laws, directives and standards that apply to this area.
Year of manufacture can be taken from the first two digits in the serial number.

IECEx Certificate	IECEx DEK 14.0047X
Marking	Ex ia IIC T6..T4 Ga Ex ia IIIC Da Ex ia I Ma
Standards:	IEC60079-11:2011, IEC60079-0: 2011, IEC60079-26:2006

Hazardous area
Zone 0, 1, 2, 20, 21, 22

Non Hazardous Area

T4: $-40 \leq T_a \leq 85^\circ\text{C}$
T5: $-40 \leq T_a \leq 60^\circ\text{C}$
T6: $-40 \leq T_a \leq 40^\circ\text{C}$

**Terminal:
41,42,43,44**
Uo: 9.6 VDC
Io: 25 mA
Po: 60 mW
Lo: 33 mH
Co: 2.4 μF

**Terminal:
51,52,53,54**
Uo: 9.6 VDC
Io: 25 mA
Po: 60 mW
Lo: 33 mH
Co: 2.4 μF

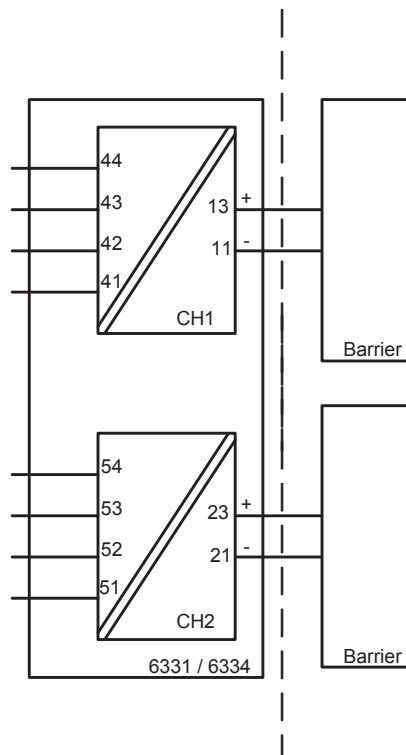

**Terminal:
11,13 and
21,23**
Ui: 30 VDC
Ii: 120 mA
Pi: 0.84 W
Li: 10 μH
Ci: 1.0 nF

General installation instructions

To avoid risk of ignition during installation and maintenance appropriate safety measures against electrostatic discharge (ESD) are to be considered.

The sensor circuit is not infallibly galvanic isolated from the supply output circuit. However, the galvanic isolation between the circuits is capable of withstanding a test voltage of 500Vac during 1 minute.

For installation in a potentially explosive gas atmosphere the following instructions apply:

To avoid risk of ignition due to electrostatic discharge (ESD) the transmitter shall be mounted in an enclosure providing a degree of protection of at least IP20 according to EN/IEC 60529.

Ambient temperature range:

T4: $-40 \leq T_a \leq 85^{\circ}\text{C}$

T5: $-40 \leq T_a \leq 60^{\circ}\text{C}$

T6: $-40 \leq T_a \leq 40^{\circ}\text{C}$

For installation in a potentially explosive dust atmosphere, the following instructions apply:

The transmitter shall be mounted in a metal enclosure or equivalent that is providing a degree of protection of at least IP6X according to EN/IEC 60529 that is suitable for the application and correctly installed. Cable entries and blanking elements shall be used that are suitable for the application and correctly installed. The surface temperature of the enclosure is equal to the ambient temperature +20K for a dust layer with a maximum thickness of 5 mm.

Ambient temperature range:

T4: $-40 \leq T_a \leq 85^{\circ}\text{C}$

For installation in a potentially explosive atmosphere in mines, the following instructions apply:

The transmitter shall be mounted in an enclosure providing a degree of protection of at least IP6X according to EN/IEC 60529. Cable entries and blanking elements shall be used that are suitable for the application and correctly installed.

Ambient temperature range:

T4: $-40 \leq T_a \leq 85^{\circ}\text{C}$

For safe installation of the single channel 6331A2A or the two channel 6331A2B the following must be observed. The module shall only be installed by qualified personnel who are familiar with the national and international laws, directives and standards that apply to this area.

Marking

Class I, Division 2, Group A,B,C,D T4..T6

Class I Zone 2 Ex/AEx nA IIC T4..T6

Class I Zone 2 Ex/AEx nA IIC T4..T6

NIFW Class I Division 2, Group A,B,C,D

T4: -40°C to 85 °C
T6: -40°C to 60 °C

Hazardous Area
CL I, Div 2, GP ABCD
CL I, Zone 2, IIC

Terminal:
41,42,43,44
Uo: 9.6 VDC
Io: 25 mA
Po: 60 mW
Lo: 33 mH
Co: 2.4 µF

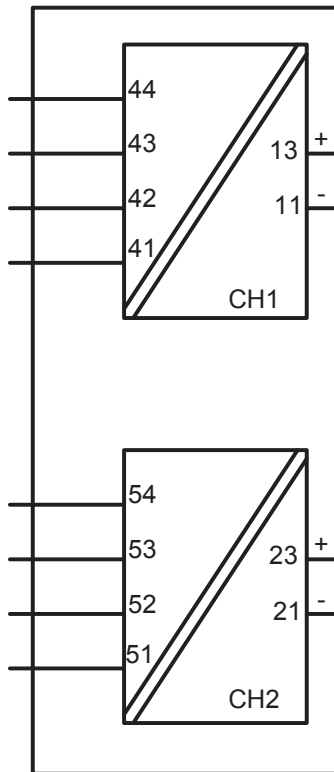

Terminal:
11-13

Functional Ratings:
U nominal ≤ 35 VDC;
I nominal ≤ 3.5 - 23 mA

Terminal:
51,52,53,54
Uo: 9.6 VDC
Io: 25 mA
Po: 60 mW
Lo: 33 mH
Co: 2.4 µF

Terminal:
21-23

Functional Ratings:
U nominal ≤ 35 VDC;
I nominal ≤ 3.5 - 23 mA

NI Installation instructions

The transmitter must be installed in an enclosure providing a degree of protection of at least IP54 according to IEC60529 that is suitable for the application and is correctly installed. Cable entry devices and blanking elements shall fulfill the same requirements.

If the enclosure is made of non-metallic materials or of painted metal, electrostatic charging shall be avoided.

Use supply wires with a rating of at least 5 K above the ambient temperature.

Supply from a Class 2 Power Supply with Transient protection or equivalent.

WARNING: Substitution of components may impair suitability for Class I, Division 2.

AVERTISSEMENT: la substitution de composants peut nuire à l'aptitude à la Classe I, Division 2.

WARNING: Do not disconnect equipment unless power has been switched off or the area is known to be safe.

AVERTISSEMENT: Ne débranchez pas l'équipement sauf si l'alimentation a été coupée ou si la zone est connue pour être sûre.

Non Incendive field wiring installation

The non incendive field Wiring Circuit concept allows interconnection of Nonincendive Field wiring Apparatus with Associated Nonincendive Field Wiring Apparatus or Associated Intrinsically Safe Apparatus or Associated Apparatus not specially examined in combination as a system using any of the wiring methods permitted for unclassified locations,

$V_{oc} < V_{max}$, $C_a \geq C_i + C_{cable}$, $L_a \geq L_i + L_{cable}$.

Hazardous (Classified) Location
IS, Class I, Division 1, Group A,B,C,D T4..T6
Ex ia IIC T4..T6 Ga
Class I, Zone 0, AEx ia IIC T4..T6 Ga

Non Hazardous Location

Terminal: 41,42,43,44
Connect to passive or non-energy storing devices such as RTD's Resistors and Thermocouples only.

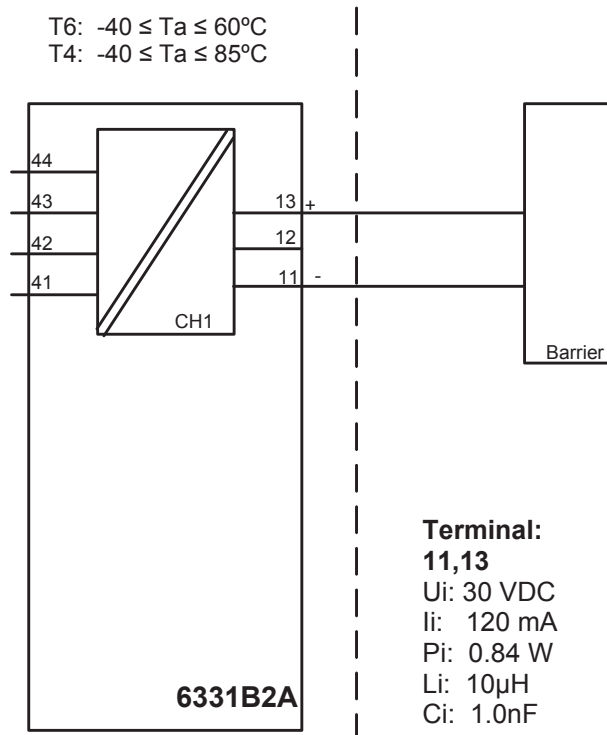

$$Co(Ca) > \sum(Ci+C_{cable})$$

$$Lo(La) > \sum(Li+L_{cable})$$

Installation notes.

The Transmitter must be installed in a suitable enclosure to meet installation codes stipulated in The Canadian Electrical Code (CEC).

Substitution of components may impair intrinsic safety.

Hazardous (Classified) Location
IS,Class I, Division 1, Group A,B,C,D T4..T6
Ex ia IIC T4..T6 Ga
Class I, Zone 0, AEx ia IIC T4..T6 Ga

Non Hazardous Location

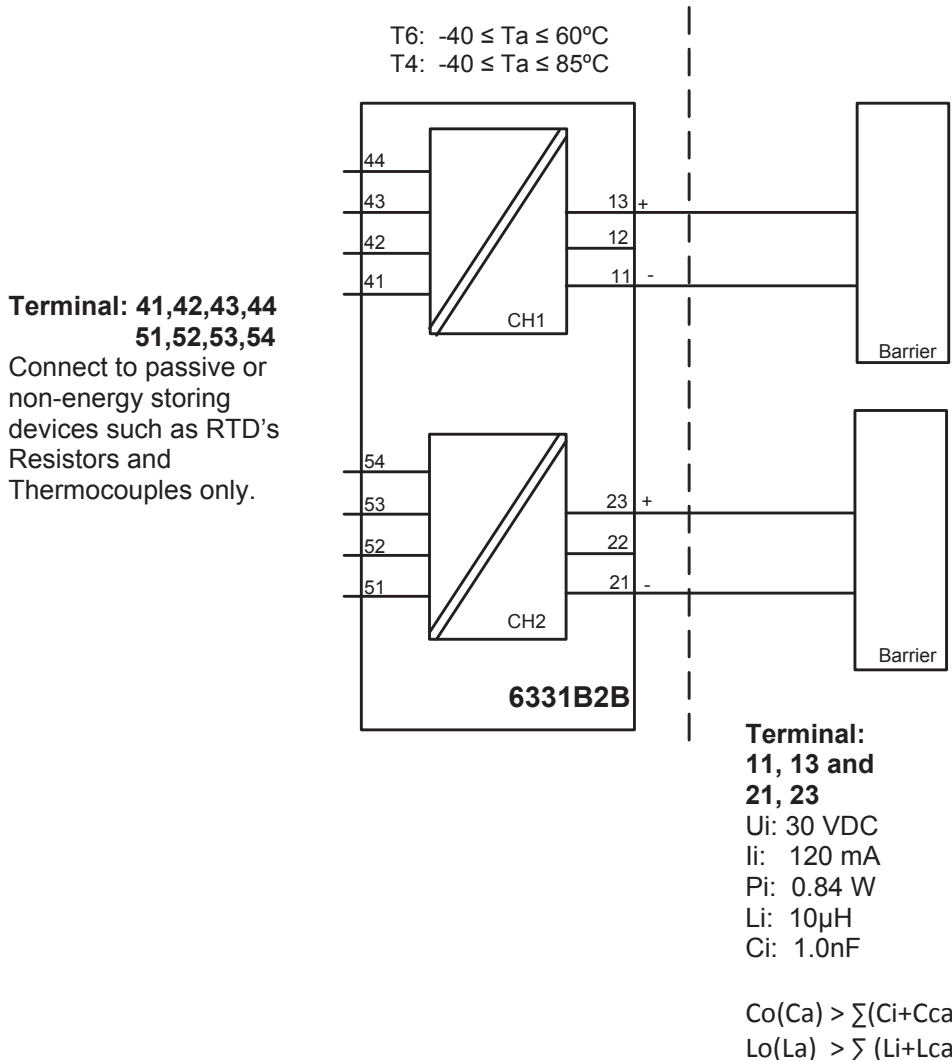

Installation notes.

The Transmitter must be installed in a suitable enclosure to meet installation codes stipulated in The Canadian Electrical Code (CEC).

Channel 1 and Channel 2 are separate channels and therefore separate shielded cables shall be used for each channel.

Substitution of components may impair intrinsic safety.

Hazardous (Classified) Location
Class I, Division 1, Group A,B,C,D T4..T6
Class I, Zone 0, AEx ia IIC T4..T6

Non Hazardous Location

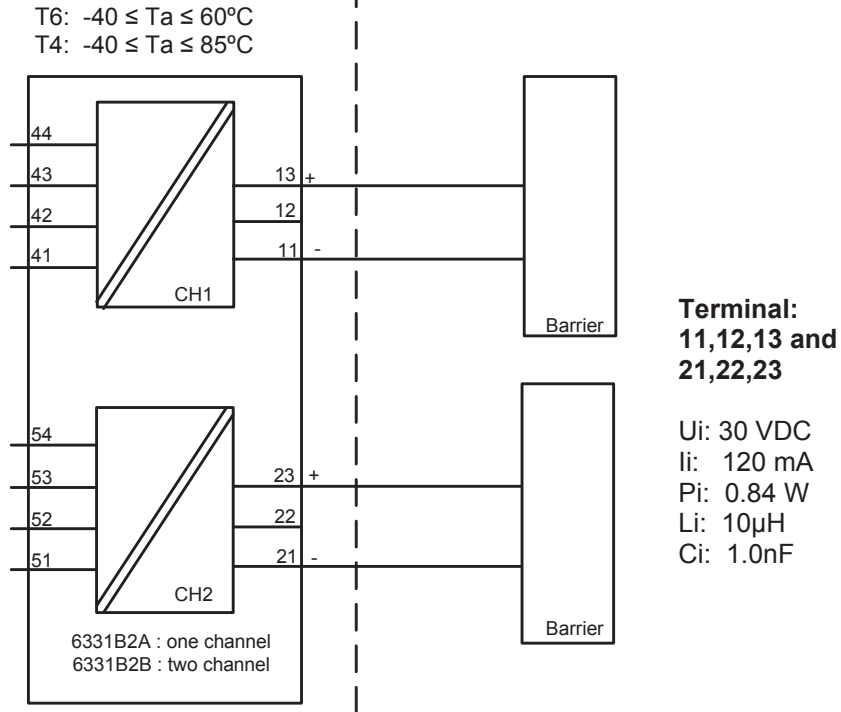

Installation notes.

For installation in Class I the Transmitter must be installed in a suitable enclosure to meet installation codes stipulated in The National Electrical Code (ANSI-NFPA 70).

Equipment that is FM-approved for intrinsic safety may be connected to barriers based on the Entity Concept. This concept permits interconnection of approved transmitters, meters and other devices in combinations, which have not been specifically examined by FM, provided that the agency's criteria are met. The combination is then intrinsically safe, if the entity concept is acceptable to the authority having jurisdiction over the installation.

The entity concept criteria are as follows: The intrinsically safe devices, other than barriers, must not be a source of power. The maximum voltage $U_i(V_{MAX})$ and current $I_i(I_{MAX})$, and maximum power $P_i(P_{max})$, which the device can receive and remain intrinsically safe, must be equal to or greater than the voltage (U_o or V_{OC} or V_t) and current (I_o or I_{SC} or I_t) and the power P_o which can be delivered by the barrier. The sum of the maximum unprotected capacitance (C_i) for each intrinsically device and the interconnecting wiring must be less than the capacitance (C_a) which can be safely connected to the barrier. The sum of the maximum unprotected inductance (L_i) for each intrinsically device and the interconnecting wiring must be less than the inductance (L_a) which can be safely connected to the barrier. The entity parameters U_o , V_{OC} or V_t and I_o , I_{SC} or I_t , and C_a and L_a for barriers are provided by the barrier manufacturer.

Hazardous (Classified) Location
Class I, Division 2, Group A,B,C,D T4..T6
Class I, Zone 2, IIC T4..T6

Non Hazardous Location

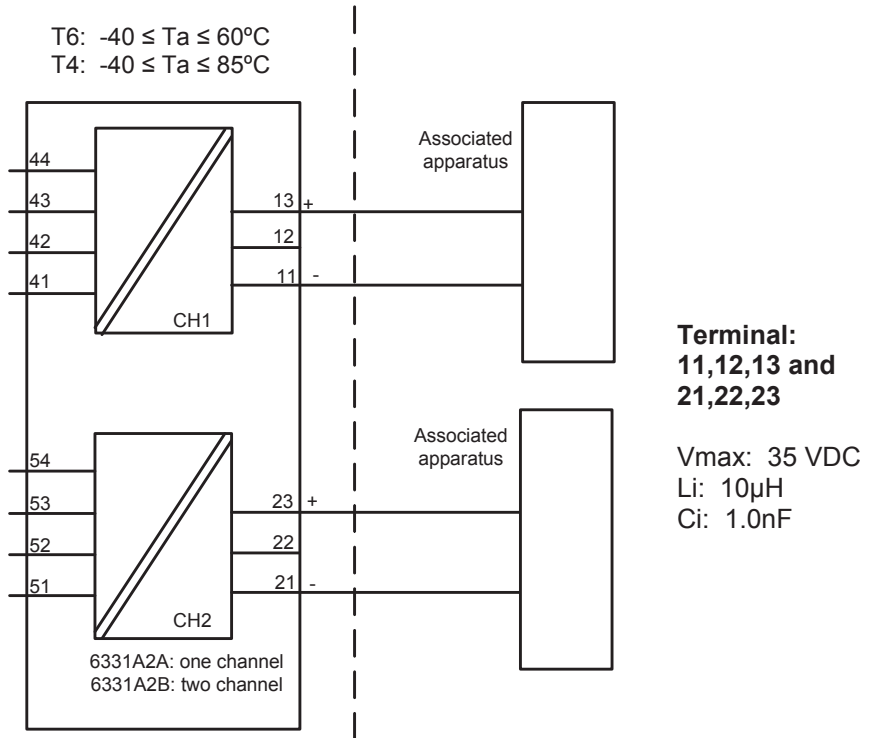

Installation notes.

The Transmitter must be installed in a suitable enclosure to meet installation codes stipulated in The National Electrical Code (ANSI-NFPA 70).

To assure a Non-Incendive system the transmitter and associated apparatus must be wired in accordance with the associated apparatus manufacturers field wiring instructions and the circuit diagram shown above.

Document history

The following list provides notes concerning revisions of this document.

Rev. ID	Date	Notes
106	1548	CSA, FM & IECEx approvals added.
107	1903	Specifications for max. required power added. New FM certificate. CSA approval for 6331A received. Installation drawing added.

We are near you, *all over the world*

Our trusted red boxes are supported wherever you are

All our devices are backed by expert service and a 5-year warranty. With each product you purchase, you receive personal technical support and guidance, day-to-day delivery, repair without charge within the warranty period and easily accessible documentation.

We are headquartered in Denmark, and have offices and authorized partners the world over. We are a local business

with a global reach. This means that we are always nearby and know your local markets well.

We are committed to your satisfaction and provide PERFORMANCE MADE SMARTER all around the world.

For more information on our warranty program, or to meet with a sales representative in your region, visit prelectronics.com.

Benefit today from *PERFORMANCE MADE SMARTER*

PR electronics is the leading technology company specialized in making industrial process control safer, more reliable and more efficient. Since 1974, we have been dedicated to perfecting our core competence of innovating high precision technology with low power consumption. This dedication continues to set new standards for products communicating, monitoring and connecting our customers' process measurement points to their process control systems.

Our innovative, patented technologies are derived from our extensive R&D facilities and from having a great understanding of our customers' needs and processes. We are guided by principles of simplicity, focus, courage and excellence, enabling some of the world's greatest companies to achieve PERFORMANCE MADE SMARTER.