

NEW
Loop through
with ELN

Industrie- und Maschinenleuchten Industrial and machine luminaires

Made in Germany



SANGEL[®]
Systemtechnik

Liebe Leser,

mit unserem Katalog „Maschinen- und Industrieleuchten, Made in Germany“ präsentieren wir Ihnen ein umfangreiches Spektrum an Leuchten, basierend auf dem neuesten Stand der LED-Technologie. Die sorgfältige Entwicklung und Herstellung vereint Effizienz und Wirtschaftlichkeit mit einem robusten Aufbau für den Einsatz im Maschinen- und Anlagenbau. Neben der Funktionalität legen wir besonderen Wert auf hohe Qualität, verbunden mit einem ansprechenden Design.

Acht Produktgruppen, variierend mit diversen Lichtabdeckungen von Einscheibensicherheitsglas bis zu diffusem Plexiglas, verschiedenen Lichtfarben und Optiken, lösen Ihre Beleuchtungsherausforderungen. Auf den folgenden Seiten finden Sie alles Wissenswerte zu unseren Leuchten, von Abmessungen über Leistungsaufnahme und Lichtstrom bis hin zu den Lichtverteilungskurven.

Gerne unterstützen wir Sie bei der richtigen Auswahl.

Sie haben weitere Anforderungen – wir helfen Ihnen, diese zu realisieren.

Dear Readers,

In our catalogue „Machine and industrial luminaires, Made in Germany“, we introduce you to our extensive range of luminaires featuring state-of-the art LED technology. During the meticulous development and manufacturing process, efficiency and cost-effectiveness are combined with a robust design suitable for use in machinery and plant construction. Alongside our focus on functionality, ensuring that our products are of premium quality with an appealing design is our top priority.

We address your lighting needs with our six product groups that vary in their colour temperatures, optics and light covers which range from single-pane safety glass to diffuse Perspex. By referring to the corresponding data sheets, you will be able to find out all you need to know about our luminaires, including their dimensions, power consumption, luminous flux and light distribution curves.

We are always on hand if you need any assistance in selecting the perfect solution to suit your needs.

We understand that you have further requirements and we are here to help you meet them.



LED Einbauleuchte
LED recessed luminaire





Unsere LED Einbauleuchte zeigt sich ganz flach. Als Einbau-Maschinenleuchte beträgt ihre Aufbauhöhe im eingebauten Zustand nur 3mm. Sie ist in 2 verschiedenen Längen erhältlich. Selbstverständlich entspricht auch die Einbauvariante des eloxierten Aluminiumgehäuses der Schutzart IP67 und ist unempfindlich gegen Spritzwasser und Staub.

Wir liefern die LED Einbauleuchte im Standard wahlweise mit 3 Meter Kabel, M8 Steckverbinder oder M12 Steckverbinder. Als Lichtabdeckung wählen Sie aus diffusem Acrylglas oder diffusem Einscheibensicherheitsglas (ESG). Sie brauchen mehr Licht!? - Dann haben Sie auch bei dieser Leuchte die Möglichkeit, sich für die Version mit klarem ESG zu entscheiden.

The design of our LED recessed luminaire is extremely flat. As a recessed machine luminaire, its installation height is just 3 mm when built in and it is available in two different lengths.

It goes without saying that the recessed version of the anodised aluminium housing also has an IP67 protection rating and is resistant to splashing water and dust.

The LED recessed luminaire comes with your choice of a 3 metre cable, M8 connector or M12 connector as standard. For the light cover, you can select from diffuse acrylic glass and diffuse single-pane safety glass. If your application requires more light, there is even a version of this luminaire with clear single-pane safety glass.

LED Einbauleuchte 250

LED recessed luminaire 250

LED Maschineneinbauleuchte mit 24V Betriebsspannung
LED recessed machine luminaire with 24V operating voltage



Einbauwandstärke: ≤ 3mm
Installation wall thickness: ≤ 3mm

Lichtverteilung | Light distribution

Lichtpunkthöhe | Light source height: 100cm

PMMA diffus | PMMA diffuse

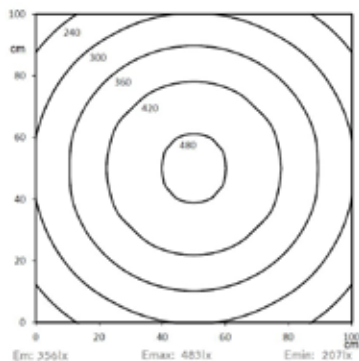

ESG diffus | Single-pane-safety glass clear

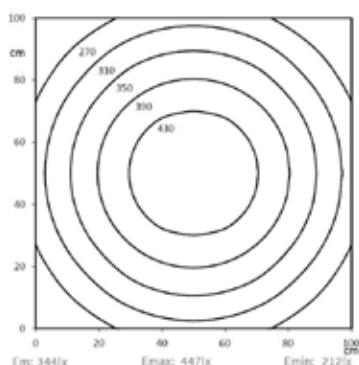

Dimensionierung | Dimensions

Maximaler Durchmesser |
Maximum diameter: Ø 8,8 mm

Senkkopfschraube |
Countersunk screw: 90°

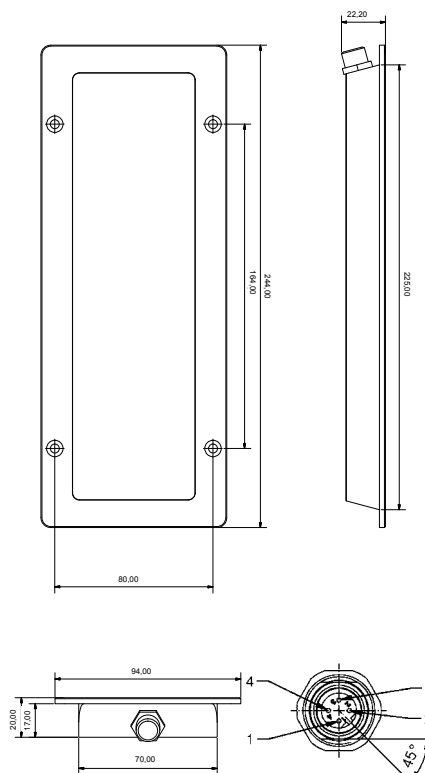

Technische Daten | Technical data

Leistungsaufnahme:	14W
Power consumption:	14W
Anschlusswert:	24V DC (-10%/+15%)
Connection value:	24V DC (-10%/+15%)
Anschlussart:	M12 Steckverbinder* oder 3m Kabel
Connection type:	M12 connector* or 3m cable
Gehäuse:	Aluminium eloxiert
Housing:	Anodised aluminium
Schutzart:	IP67
Protection rating:	IP67
Schutzklasse:	III
Protection class:	III
Abdeckung:	ESG klar, PMMA diffus oder ESG diffus
Cover:	PMMA diffuse, single- pane safety glass diffuse or single-pane safety glass clear
Farbtreue:	Ra / CRI ≥ 80
Colour rendering:	Ra / CRI ≥ 80
Lebensdauer:	min. 60 000h
Service life:	min. 60 000h
Lichtstrom:	ca. 1608 lm
Luminous flux:	Approx. 1608 lm
Max. Umgebungstemperatur:	-20°C / +45°C
Max. ambient temperature:	-20°C / +45°C
Belegung:	1 = DC (+) br br
Pin assignment:	2 = Eco (DC+) ws wh
	3 = DC (-) bl bl
	4 = NC

Normen / Approbationen Standards / approvals

DIN EN 55015 (EMV)
DIN EN 61547 (EMV)
DIN EN 60598-1
DIN EN 62471

Sangel-Bezeichnung Sangel description	Katalognr. Catalogue no.	Abdeckung Cover	Optik Optics	Anschlussart Connection type	Lichtfarbe Colour temperature
250 DIFF-0-3M-55	12080073	PMMA diffus PMMA diffuse	ohne Optik, 120° without optics, 120°	3m Kabel 3m cable	5.700K
250 ESGd-0-3M-55	12080074	ESG diffus Single-pane safety glass diffuse	ohne Optik, 120° without optics, 120°	3m Kabel 3m cable	5.700K
250 ESGk-0-3M-55	12080075	ESG klar Single-pane safety glass clear	ohne Optik, 120° without optics, 120°	3m Kabel 3m cable	5.700K
250 DIFF-0-M12-55	12080076	PMMA diffus PMMA diffuse	ohne Optik, 120° without optics, 120°	M12 Steckverbinder* M12 connector*	5.700K
250 ESGd-0-M12-55	12080077	ESG diffus Single-pane safety glass diffuse	ohne Optik, 120° without optics, 120°	M12 Steckverbinder* M12 connector*	5.700K
250 ESGk-0-M12-55	12080078	ESG klar Single-pane safety glass clear	ohne Optik, 120° without optics, 120°	M12 Steckverbinder* M12 connector*	5.700K
250 DIFF-0-3M-40	12080079	PMMA diffus PMMA diffuse	ohne Optik, 120° without optics, 120°	3m Kabel 3m cable	4.000K
250 ESGd-0-3M-40	12080080	ESG diffus Single-pane safety glass diffuse	ohne Optik, 120° without optics, 120°	3m Kabel 3m cable	4.000K
250 ESGk-0-3M-40	12080081	ESG klar Single-pane safety glass clear	ohne Optik, 120° without optics, 120°	3m Kabel 3m cable	4.000K
250 DIFF-0-M12-40	12080082	PMMA diffus PMMA diffuse	ohne Optik, 120° without optics, 120°	M12 Steckverbinder* M12 connector*	4.000K
250 ESGd-0-M12-40	12080083	ESG diffus Single-pane safety glass diffuse	ohne Optik, 120° without optics, 120°	M12 Steckverbinder* M12 connector*	4.000K
250 ESGk-0-M12-40	12080084	ESG klar Single-pane safety glass clear	ohne Optik, 120° without optics, 120°	M12 Steckverbinder* M12 connector*	4.000K



*Die passenden Anschlussleitungen finden Sie auf Seite 73. | The corresponding connection cables can be found on page 73.

LED Einbauleuchte 450

LED recessed luminaire 450

LED Maschineneinbauleuchte mit 24V Betriebsspannung
LED recessed machine luminaire with 24V operating voltage



Einbauwandstärke: ≤ 3mm
Installation wall thickness: ≤ 3mm

Lichtverteilung | Light distribution

Lichtpunkthöhe | Light source height: 100cm

PMMA diffus | PMMA diffuse

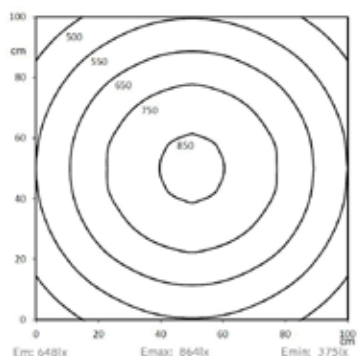

ESG diffus | Single-pane-safety glass clear

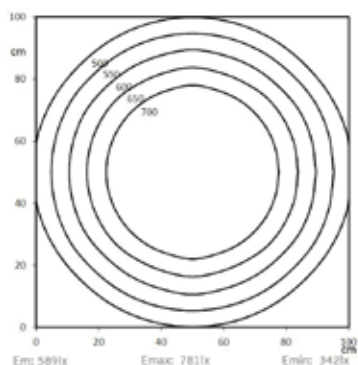

Dimensionierung | Dimensions

Maximaler Durchmesser |
Maximum diameter: Ø 8,8 mm

Senkkopfschraube |
Countersunk screw: 90°

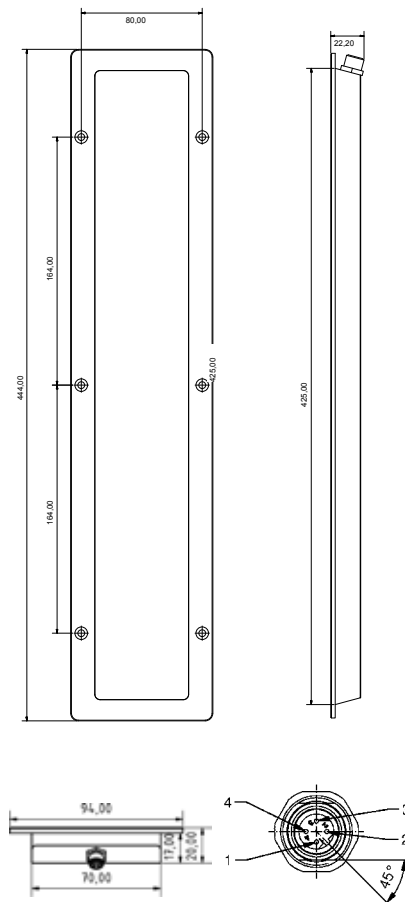

Technische Daten | Technical data

Leistungsaufnahme: 28W
Power consumption: 28W

Anschlusswert: 24V DC (-10%/+15%)
Connection value: 24V DC (-10%/+15%)

Anschlussart: M12 Steckverbinder*
oder 3m Kabel
Connection type: M12 connector* or
3m cable

Gehäuse: Aluminium eloxiert
Housing: Anodised aluminium

Schutzart: IP67
Protection rating: IP67

Schutzklasse: III
Protection class: III

Abdeckung: ESG klar, PMMA diffus
oder ESG diffus
Cover: PMMA diffuse, single-
pane safety glass
diffuse or single-pane
safety glass clear

Farbtreue: Ra / CRI ≥ 80
Colour rendering: Ra / CRI ≥ 80

Lebensdauer: min. 60 000h
Service life: min. 60 000h

Lichtstrom: ca. 3216 lm
Luminous flux: Approx. 3216 lm

Max. Umgebungstemperatur: -20°C / +45°C
Max. ambient
temperature: -20°C / +45°C

Belegung: 1 = DC (+) br | br
Pin assignment: 2 = Eco (DC+) ws | wh
3 = DC (-) bl | bl
4 = NC

Normen / Approbationen Standards / approvals

DIN EN 55015 (EMV)

DIN EN 61547 (EMV)

DIN EN 60598-1

DIN EN 62471

Sangel-Bezeichnung Sangel description	Katalognr. Catalogue no.	Abdeckung Cover	Optik Optics	Anschlussart Connection type	Lichtfarbe Colour temperature
450 DIFF-0-3M-55	12080085	PMMA diffus PMMA diffuse	ohne Optik, 120° without optics, 120°	3m Kabel 3m cable	5.700K
450 ESGd-0-3M-55	12080086	ESG diffus Single-pane safety glass diffuse	ohne Optik, 120° without optics, 120°	3m Kabel 3m cable	5.700K
450 ESGk-0-3M-55	12080087	ESG klar Single-pane safety glass clear	ohne Optik, 120° without optics, 120°	3m Kabel 3m cable	5.700K
450 DIFF-0-M12-55	12080088	PMMA diffus PMMA diffuse	ohne Optik, 120° without optics, 120°	M12 Steckverbinder* M12 connector*	5.700K
450 ESGd-0-M12-55	12080089	ESG diffus Single-pane safety glass diffuse	ohne Optik, 120° without optics, 120°	M12 Steckverbinder* M12 connector*	5.700K
450 ESGk-0-M12-55	12080090	ESG klar Single-pane safety glass clear	ohne Optik, 120° without optics, 120°	M12 Steckverbinder* M12 connector*	5.700K
450 DIFF-0-3M-40	12080091	PMMA diffus PMMA diffuse	ohne Optik, 120° without optics, 120°	3m Kabel 3m cable	4.000K
450 ESGd-0-3M-40	12080092	ESG diffus Single-pane safety glass diffuse	ohne Optik, 120° without optics, 120°	3m Kabel 3m cable	4.000K
450 ESGk-0-3M-40	12080093	ESG klar Single-pane safety glass clear	ohne Optik, 120° without optics, 120°	3m Kabel 3m cable	4.000K
450 DIFF-0-M12-40	12080094	PMMA diffus PMMA diffuse	ohne Optik, 120° without optics, 120°	M12 Steckverbinder* M12 connector*	4.000K
450 ESGd-0-M12-40	12080095	ESG diffus Single-pane safety glass diffuse	ohne Optik, 120° without optics, 120°	M12 Steckverbinder* M12 connector*	4.000K
450 ESGk-0-M12-40	12080096	ESG klar Single-pane safety glass clear	ohne Optik, 120° without optics, 120°	M12 Steckverbinder* M12 connector*	4.000K

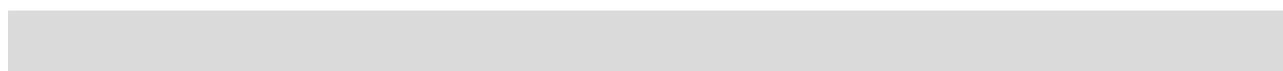

*Die passenden Anschlussleitungen finden Sie auf Seite 73. | The corresponding connection cables can be found on page 73.

LED Einbauleuchte T250

LED recessed luminaire T250

LED Maschineneinbauleuchte mit 24V Betriebsspannung
LED recessed machine luminaire with 24V operating voltage



Einbauwandstärke: ≤ 10mm
Installation wall thickness: ≤ 10mm

Lichtverteilung | Light distribution

Lichtpunkthöhe | Light source height: 100cm

PMMA diffus | PMMA diffuse

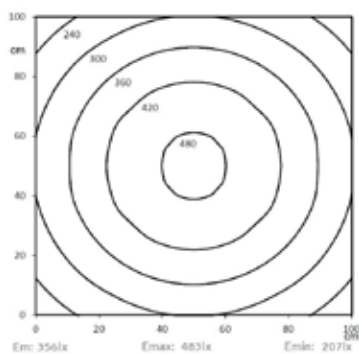

ESG diffus | Single-pane-safety glass clear

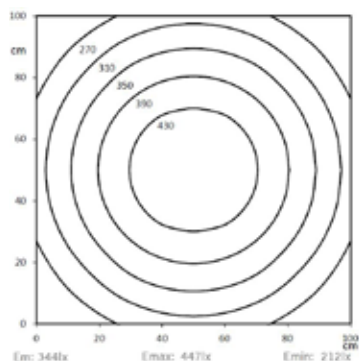

Dimensionierung | Dimensions

Maximaler Durchmesser |
Maximum diameter: Ø 8,8 mm

Senkkopfschraube |
Countersunk screw: 90°

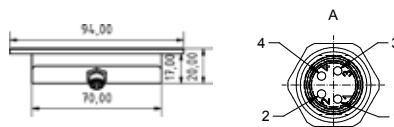
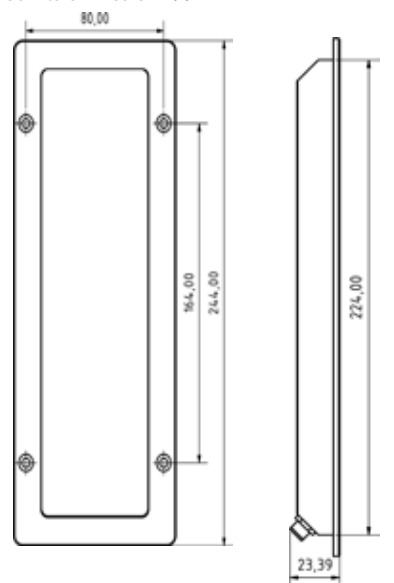

Technische Daten | Technical data

Leistungsaufnahme:	14W
Power consumption:	14W
Anschlusswert:	24V DC (-10%/+15%)
Connection value:	24V DC (-10%/+15%)
Anschlussart:	M8 Steckverbinder* oder 3m Kabel
Connection type:	M8 connector* or 3m cable
Gehäuse:	Aluminium eloxiert
Housing:	Anodised aluminium
Schutzart:	IP67
Protection rating:	IP67
Schutzklasse:	III
Protection class:	III
Abdeckung:	ESG klar, PMMA diffus oder ESG diffus
Cover:	PMMA diffuse, single- pane safety glass diffuse or single-pane safety glass clear
Farbtreue:	Ra / CRI ≥ 80
Colour rendering:	Ra / CRI ≥ 80
Lebensdauer:	min. 60 000h
Service life:	min. 60 000h
Lichtstrom:	ca. 1608 lm
Luminous flux:	Approx. 1608 lm
Max. Umgebungstemperatur:	-20°C / +45°C
Max. ambient temperature:	-20°C / +45°C
Belegung:	1 = DC (+) br br
Pin assignment:	2 = Eco (DC+) ws wh
	3 = DC (-) bl bl
	4 = NC

Normen / Approbationen Standards / approvals

DIN EN 55015 (EMV)
DIN EN 61547 (EMV)
DIN EN 60598-1
DIN EN 62471

Sangel-Bezeichnung Sangel description	Katalognr. Catalogue no.	Abdeckung Cover	Optik Optics	Anschlussart Connection type	Lichtfarbe Colour temperature
T250 DIFF-0-3M-55	15070251	PMMA diffus PMMA diffuse	ohne Optik, 120° without optics, 120°	3m Kabel 3m cable	5.700K
T250 ESGd-0-3M-55	15070252	ESG diffus Single-pane safety glass diffuse	ohne Optik, 120° without optics, 120°	3m Kabel 3m cable	5.700K
T250 ESGk-0-3M-55	15070253	ESG klar Single-pane safety glass clear	ohne Optik, 120° without optics, 120°	3m Kabel 3m cable	5.700K
T250 DIFF-0-M12-55	15070254	PMMA diffus PMMA diffuse	ohne Optik, 120° without optics, 120°	M8 Steckverbinder* M8 connector*	5.700K
T250 ESGd-0-M12-55	15070255	ESG diffus Single-pane safety glass diffuse	ohne Optik, 120° without optics, 120°	M8 Steckverbinder* M8 connector*	5.700K
T250 ESGk-0-M12-55	15070256	ESG klar Single-pane safety glass clear	ohne Optik, 120° without optics, 120°	M8 Steckverbinder* M8 connector*	5.700K
T250 DIFF-0-3M-40	15070257	PMMA diffus PMMA diffuse	ohne Optik, 120° without optics, 120°	3m Kabel 3m cable	4.000K
T250 ESGd-0-3M-40	15070258	ESG diffus Single-pane safety glass diffuse	ohne Optik, 120° without optics, 120°	3m Kabel 3m cable	4.000K
T250 ESGk-0-3M-40	15070259	ESG klar Single-pane safety glass clear	ohne Optik, 120° without optics, 120°	3m Kabel 3m cable	4.000K
T250 DIFF-0-M12-40	15070260	PMMA diffus PMMA diffuse	ohne Optik, 120° without optics, 120°	M8 Steckverbinder* M8 connector*	4.000K
T250 ESGd-0-M12-40	15070261	ESG diffus Single-pane safety glass diffuse	ohne Optik, 120° without optics, 120°	M8 Steckverbinder* M8 connector*	4.000K
T250 ESGk-0-M12-40	15070262	ESG klar Single-pane safety glass clear	ohne Optik, 120° without optics, 120°	M8 Steckverbinder* M8 connector*	4.000K

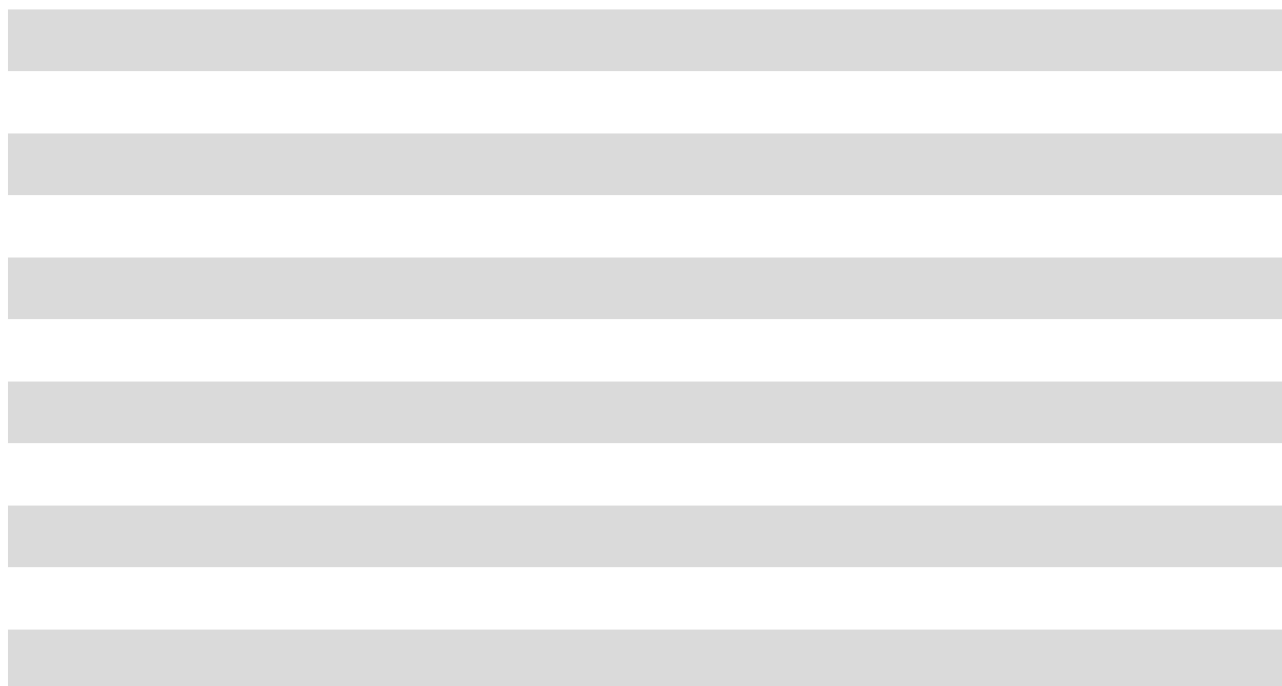

*Die passenden Anschlussleitungen finden Sie auf Seite 72. | The corresponding connection cables can be found on page 72.

LED Einbauleuchte T450

LED recessed luminaire T450

LED Maschineneinbauleuchte mit 24V Betriebsspannung
LED recessed luminaire with 24V operating voltage

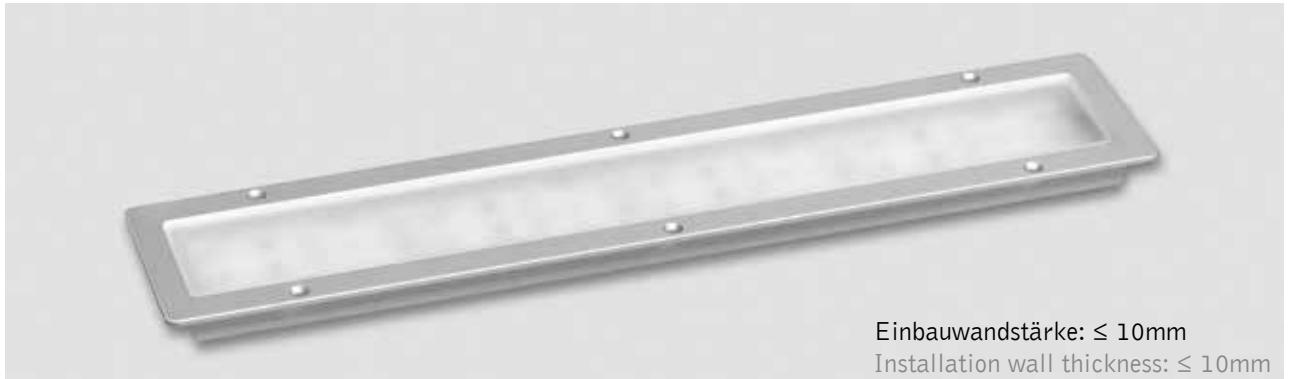

Einbauwandstärke: ≤ 10mm
Installation wall thickness: ≤ 10mm

Lichtverteilung | Light distribution

Lichtpunkthöhe | Light source height: 100cm

PMMA diffus | PMMA diffuse

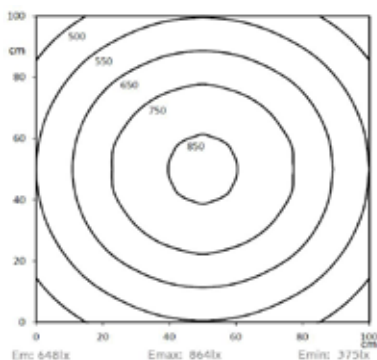

ESG diffus | Single-pane-safety glass clear

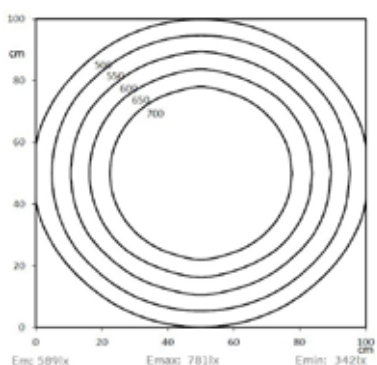

Dimensionierung | Dimensions

Maximaler Durchmesser |
Maximum diameter: Ø 8,8 mm

Senkkopfschraube |
Countersunk screw: 90°

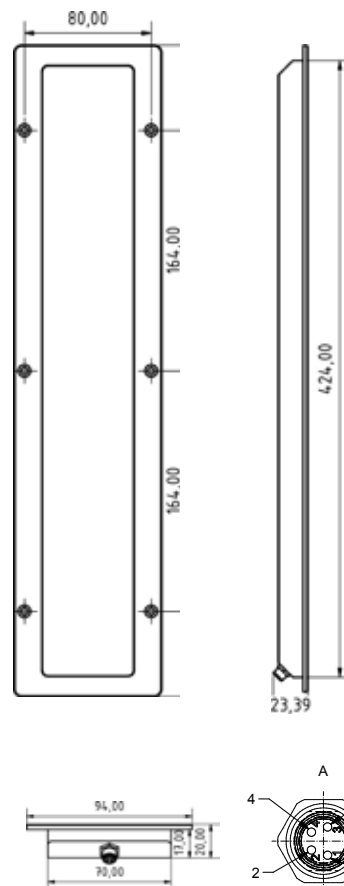

Technische Daten | Technical data

Leistungsaufnahme:	28W
Power consumption:	28W
Anschlusswert:	24V DC (-10%/+15%)
Connection value:	24V DC (-10%/+15%)
Anschlussart	M8 Steckverbinder* oder 3m Kabel
Connection type	M8 connector* or 3m cable
Gehäuse:	Aluminium eloxiert
Housing:	Anodised aluminium
Schutzart:	IP67
Protection rating:	IP67
Schutzklasse:	III
Protection class:	III
Abdeckung:	ESG klar, PMMA diffus oder ESG diffus
Cover	PMMA diffuse, single- pane safety glass diffuse or single-pane safety glass clear
Farbtreue:	Ra / CRI ≥ 80
Colour rendering:	Ra / CRI ≥ 80
Lebensdauer:	min. 60 000h
Service life:	min. 60 000h
Lichtstrom:	ca. 1608 lm
Luminous flux:	Approx. 1608 lm
Max. Umgebungstemperatur:	-20°C / +45°C
Max. ambient temperature:	-20°C / +45°C
Belegung:	1 = DC (+) br br
Pin assignment	2 = Eco (DC+) ws wh
	3 = DC (-) bl bl
	4 = NC

Normen / Approbationen Standards / Approvals

DIN EN 55015 (EMV)
DIN EN 61547 (EMV)
DIN EN 60598-1
DIN EN 62471

Sangel-Bezeichnung Sangel description	Katalognr. Catalogue no.	Abdeckung Cover	Optik Optics	Anschlussart Connection type	Lichtfarbe Colour temperature
T450 DIFF-0-3M-55	15070263	PMMA diffus PMMA diffuse	ohne Optik, 120° without optics, 120°	3m Kabel 3m cable	5.700K
T450 ESGd-0-3M-55	15070264	ESG diffus Single-pane safety glass diffuse	ohne Optik, 120° without optics, 120°	3m Kabel 3m cable	5.700K
T450 ESGk-0-3M-55	15070265	ESG klar Single-pane safety glass clear	ohne Optik, 120° without optics, 120°	3m Kabel 3m cable	5.700K
T450 DIFF-0-M12-55	15070266	PMMA diffus PMMA diffuse	ohne Optik, 120° without optics, 120°	M8 Steckverbinder* M8 connector*	5.700K
T450 ESGd-0-M12-55	15070267	ESG diffus Single-pane safety glass diffuse	ohne Optik, 120° without optics, 120°	M8 Steckverbinder* M8 connector*	5.700K
T450 ESGk-0-M12-55	15070268	ESG klar Single-pane safety glass clear	ohne Optik, 120° without optics, 120°	M8 Steckverbinder* M8 connector*	5.700K
T450 DIFF-0-3M-40	15070269	PMMA diffus PMMA diffuse	ohne Optik, 120° without optics, 120°	3m Kabel 3m cable	4.000K
T450 ESGd-0-3M-40	15070270	ESG diffus Single-pane safety glass diffuse	ohne Optik, 120° without optics, 120°	3m Kabel 3m cable	4.000K
T450 ESGk-0-3M-40	15070271	ESG klar Single-pane safety glass clear	ohne Optik, 120° without optics, 120°	3m Kabel 3m cable	4.000K
T450 DIFF-0-M12-40	15070272	PMMA diffus PMMA diffuse	ohne Optik, 120° without optics, 120°	M8 Steckverbinder* M8 connector*	4.000K
T450 ESGd-0-M12-40	15070273	ESG diffus Single-pane safety glass diffuse	ohne Optik, 120° without optics, 120°	M8 Steckverbinder* M8 connector*	4.000K
T450 ESGk-0-M12-40	15070274	ESG klar Single-pane safety glass clear	ohne Optik, 120° without optics, 120°	M8 Steckverbinder* M8 connector*	4.000K



*Die passenden Anschlussleitungen finden Sie auf Seite 72. | The corresponding connection cables can be found on page 72.

M12x1 Anschlussleitung



M12x1 connection cable

Sangel-Bezeichnung Sangel description	Katalognr. Catalogue no.	Leitungslänge in m Cable length in m	Polzahl Pole number	Typ Type
--	-----------------------------	---	------------------------	-------------

Li9Y11Y, PVC, grau; 0,34mm² | Li9Y11Y, PVC, grey; 0,34mm²

SAL-12-RK4-2/A1	12070413	2	4	
SAL-12-RK4-3/A1	12070414	3	4	
SAL-12-RK4-5/A1	12070415	5	4	
SAL-12-RK4/10/A	12070416	10	4	

LiYY, PUR, schwarz; 0,34mm² | LiYY, PUR, black; 0,34mm²

SAL-12-RK4-2/K1	12070417	2	4	
SAL-12-RK4-3/K1	12070418	3	4	
SAL-12-RK4-5/K1	12070419	5	4	
SAL-12-RK4-10/K1	12070420	10	4	
SAL-12-RK4-RS4-0,3/K1	12070789	0,3	4	
SAL-12-RK4-RS4-0,6/K1	12070790	0,6	4	
SAL-12-RK4-RS4-1,5/K1	12070791	1,5	4	
SAL-12-RK4-RS4-3/K1	12070792	3	4	

Weitere Längen und Leitungsaufbauten auf Anfrage. | Different lengths and cable designs available on request.

Netzteile power supplies

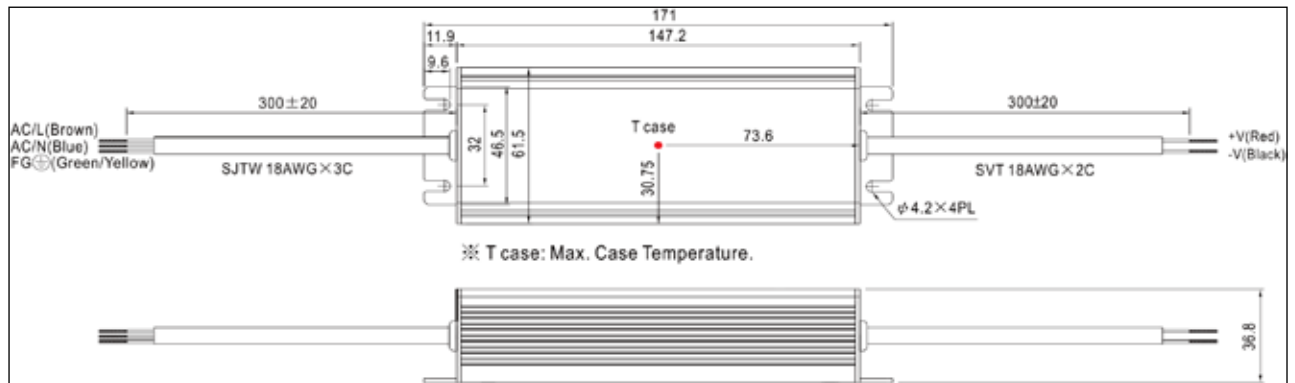

Sangel-Bezeichnung Sangel description	Katalognr. Catalogue no.	Ausgangsnennspannung Output nominal voltage	Leistung Power	Schutzart Protection type	Eingangsspannung Input voltage range
HLG-40H-24	15070071	24 V	40.08W	IP67	90 – 305VAC
HLG-60H-24	15070072	24 V	60W	IP67	90 – 305VAC

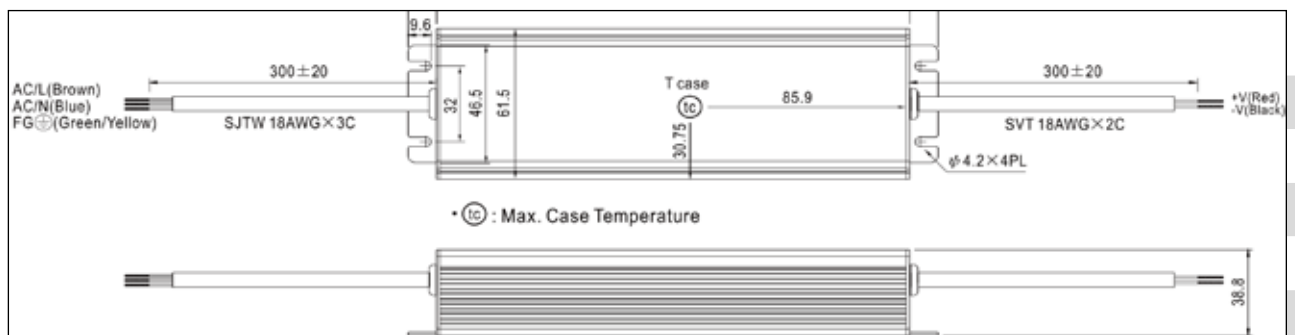

Sangel-Bezeichnung Sangel description	Katalognr. Catalogue no.	Ausgangsnennspannung Output nominal voltage	Leistung Power	Schutzart Protection type	Eingangsspannung Input voltage range
HLG-80H-24	15070073	24 V	81.6W	IP67	90 – 305VAC

Netzteile power supplies

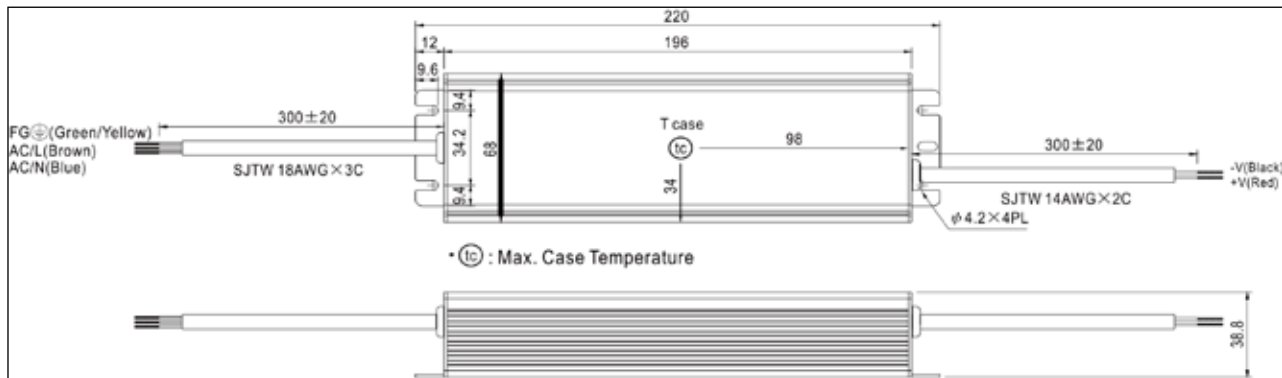

Sangel-Bezeichnung Sangel description	Katalognr. Catalogue no.	Ausgangs-nennspannung Output nominal voltage	Leistung Power	Schutzart Protection type	Eingangsspannung Input voltage range
HLG-100H-24	15070074	24V	96W	IP67	90 – 305VAC
HLG-120H-24	15070075	24V	120W	IP67	90 – 305VAC

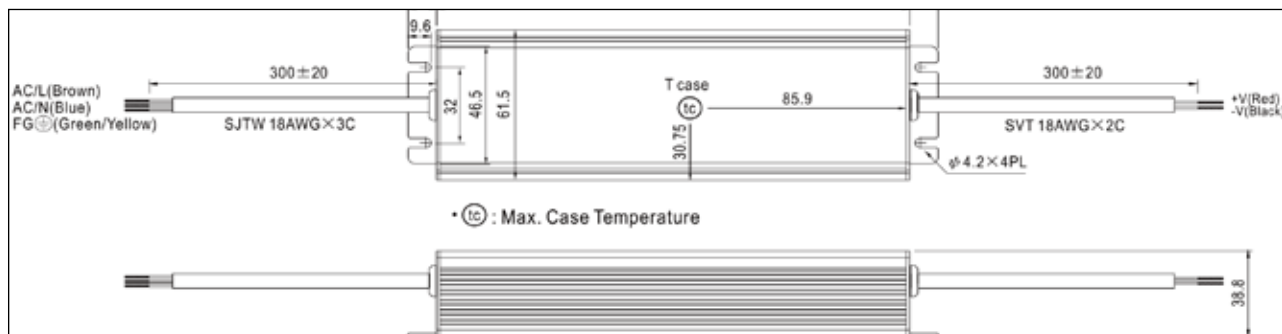

Sangel-Bezeichnung Sangel description	Katalognr. Catalogue no.	Ausgangs-nennspannung Output nominal voltage	Leistung Power	Schutzart Protection type	Eingangsspannung Input voltage range
HLG-150H-24	15070076	24V	151.2 W	IP67	90 – 305VAC
HLG-185H-24	15070077	24V	187.2W	IP67	90 – 305VAC

Netzteile power supplies

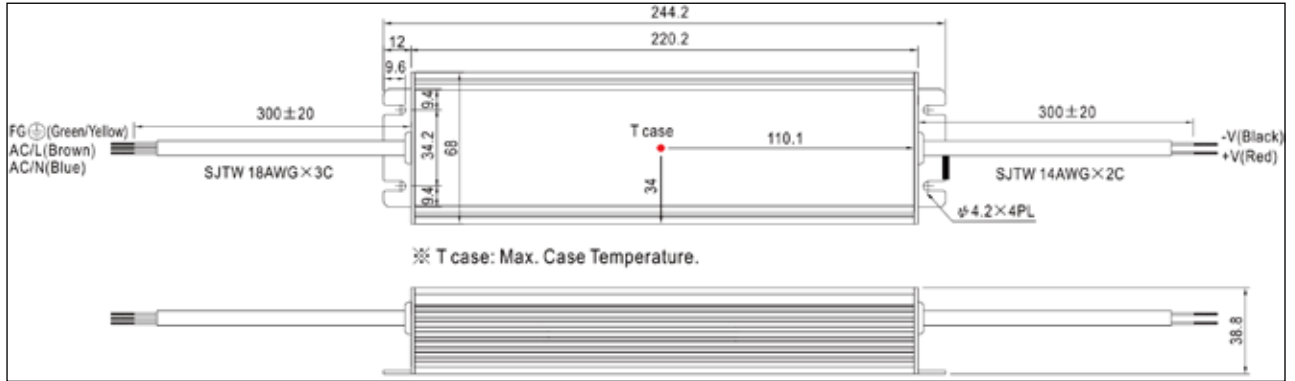

Sangel-Bezeichnung Sangel description	Katalognr. Catalogue no.	Ausgangsnennspannung Output nominal voltage	Leistung Power	Schutzart Protection type	Eingangsspannung Input voltage rating
HLG-240H-24	15070078	24V	240W	IP67	90 – 305VAC



SANGEL® Systemtechnik GmbH
Schillerstraße 44
33609 Bielefeld
Fon +49 (0)521.91175-0
Fax +49 (0)521.91175-75
www.sangel.com
sales@sangel.com

Ausgabe 3 | 2017
0-000000-013313

SANGEL®
Systemtechnik